



for a greener tomorrow



**MITSUBISHI
ELECTRIC**

Changes for the Better

FACTORY AUTOMATION

MITSUBISHI ELECTRIC INDUSTRIAL ROBOT FR Series

e-Factory



MELFA **FR**
SERIES

GLOBAL IMPACT OF MITSUBISHI ELECTRIC



Through Mitsubishi Electric's vision, "Changes for the Better" are possible for a brighter future.

Changes for the Better

We bring together the best minds to create the best technologies. At Mitsubishi Electric, we understand that technology is the driving force of change in our lives. By bringing greater comfort to daily life, maximizing the efficiency of businesses and keeping things running across society, we integrate technology and innovation to bring changes for the better.

Mitsubishi Electric is involved in many areas including the following

Energy and Electric Systems

A wide range of power and electrical products from generators to large-scale displays.

Electronic Devices

A wide portfolio of cutting-edge semiconductor devices for systems and products.

Home Appliance

Dependable consumer products like air conditioners and home entertainment systems.

Information and Communication Systems

Commercial and consumer-centric equipment, products and systems.

Industrial Automation Systems

Maximizing productivity and efficiency with cutting-edge automation technology.

OVERVIEW

Product Lineup	7	1
Functions	11	2
Robot Specifications	33	3
Controller Specifications	51	4
Robot Option Specifications	53	5
System Configuration / Controller Option Specifications	57	6
Options	63	7
Technical Information	74	8

The new future of automation made by next-generation intelligent robots



Providing improvements in productivity, quality, environmental protection, safety and security to help reduce companies' TCO* and boost their corporate value

We offer solutions that use FA technology and IT to reduce total costs in everything from development through to production and maintenance, supporting customers to continuously improve their business operations and achieve truly cutting-edge manufacturing.

*TCO: Total Cost of Ownership

e-F@ctory is Mitsubishi Electric's trademark and registered trademark.

Seeing: Improvement

IT systems feed the results of analysis back into the production site

IT systems

Observing: Analysis

Primary processing of data collected using FA (edge computing) Seamless integration with IT systems

Edge computing

Watching: Visibility

Collecting production site data in real time

Production site

Helping to increase corporate value through "Visibility^{3 (cubed)}—seeing, observing, watching" and "Usability"



Introducing the next generation of intelligent robots, incorporating advanced solutions technology and "e-F@ctory", technologies and concepts developed and proven using Mitsubishi Electric's own production facilities that go beyond basic robotic performance to find ways of reducing the TCO in everything from planning and design through to operation and maintenance.

possible and e-F@ctory

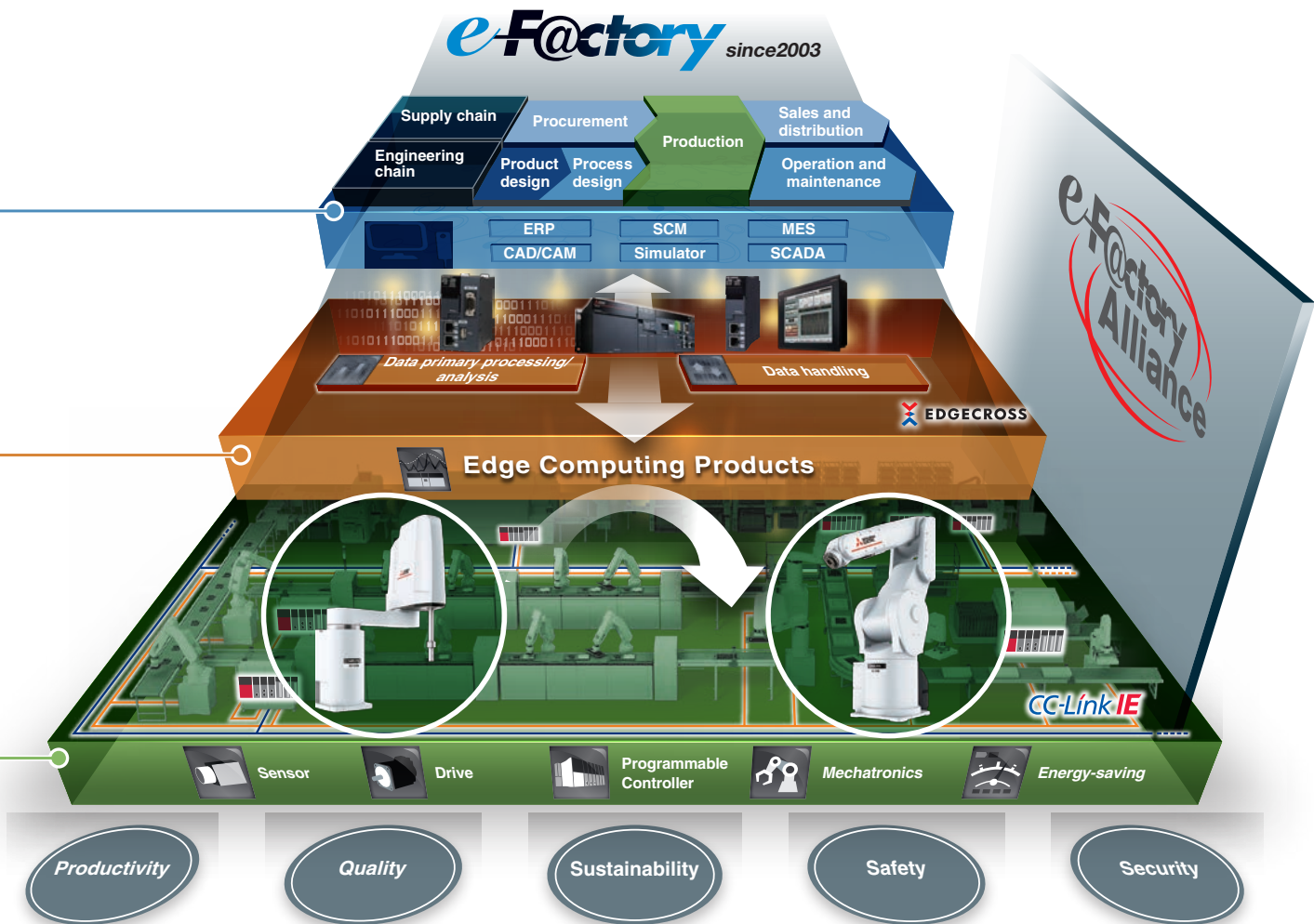

MELFA

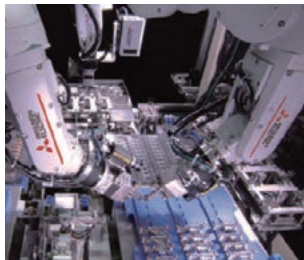

Cellular manufacturing



Assembly and Inspection



Parts supply

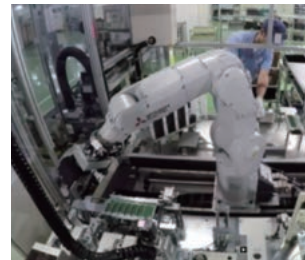

High mix production

Evolved intelligence realizes advances in work procedures, cooperation between people and robots, and e-F@ctory-compatibility, making next-generation manufacturing a reality.

With globalization and increasingly diverse consumer needs in the market, the manufacturing industries face a time of considerable change. It is no longer enough for industrial robots to simply perform a single task. Industry now demands robots with the capacity and flexibility to readily take on more sophisticated tasks. The MELFA FR series provides new, more intelligent solutions that underpin "next-generation manufacturing", offering a simpler approach to advanced and flexible production. These robots can handle all your automation needs.

MELFA FR Series

"Next-generation intelligent functions" make it simple to carry out work that has always defied automation. "Safe, collaborative work applications" allow robots and people to work together with high levels of safety. "FA-IT integration functions" support next-generation manufacturing. With these 3 key features, the FR Series is capable of handling virtually all your automation needs.

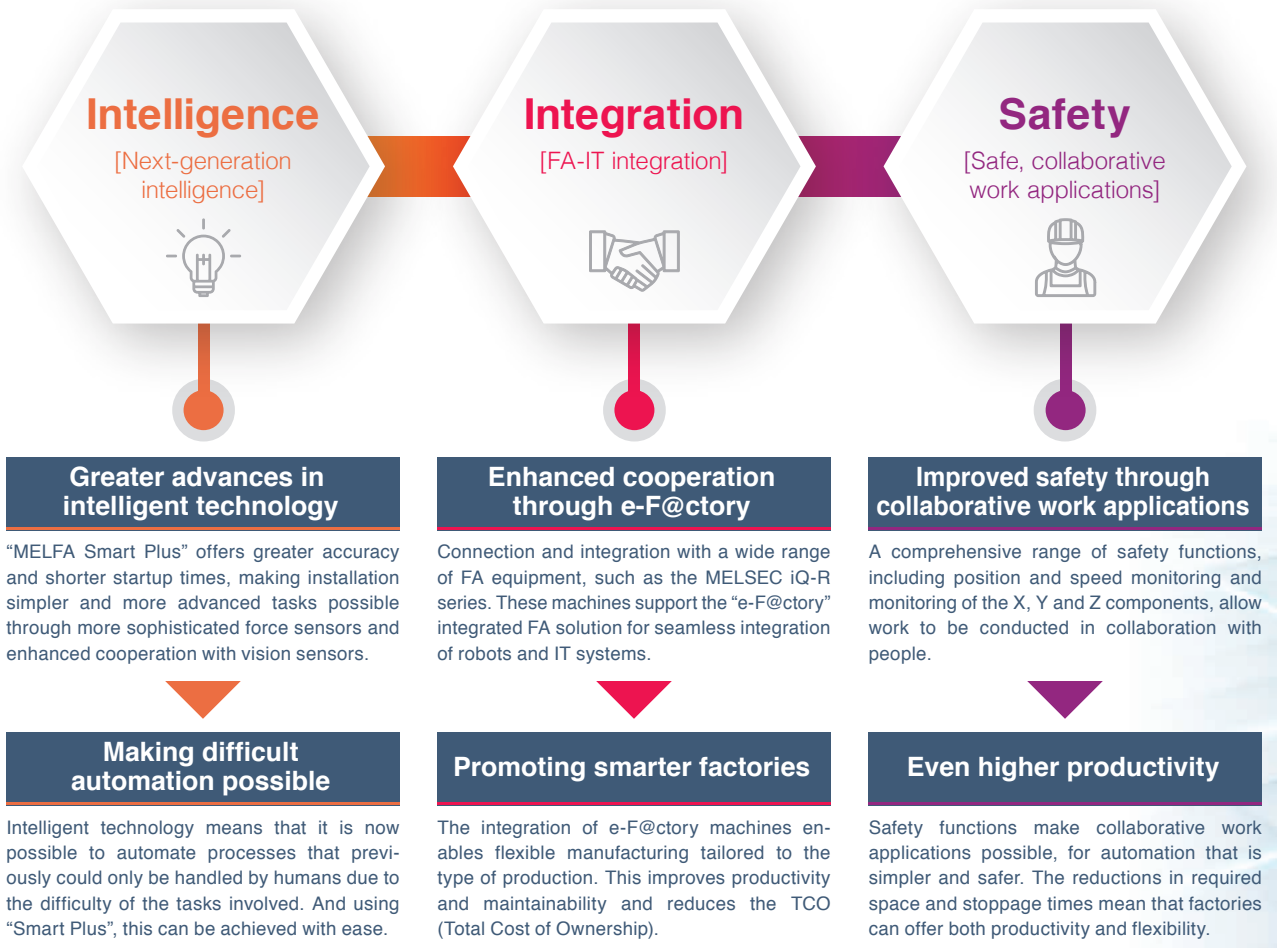

MELFA Smart Plus

Function expansion options further broaden the range of possibilities of the MELFA FR series, offering performance beyond your expectations.



Integration with the MELSEC iQ-R series PLCs enables more advanced tasks!

Integrating these robots with the Mitsubishi Electric MELSEC iQ-R PLCs simplifies startup and improves productivity and maintainability, ensuring that you maximize the potential of the FR series.



 MITSUBISHI
ELECTRIC

MELFA **FR**

SERIES

Horizontal, multiple-joint type robots

RH-FR SERIES

- With a wealth of operating areas and variations, it is the perfect fit for a variety of applications.
- Highly rigid arms and cutting-edge servo controls provide superb precision and speed. Ideal for a wide range of fields, from high-volume production of foodstuffs and pharmaceuticals that demands fast operation, through to assembly work where high levels of precision are required.



■ Horizontal, multiple-joint type (RH) series

Type	RH-3FRH	RH-6FRH	RH-12FRH	RH-20FRH	RH-3FRHR
Maximum load capacity	3kg	6kg	12kg	20kg	3kg
Maximum reach radius	350mm 450mm 550mm	350mm 450mm 550mm	700mm 850mm 1000mm		350mm
Z stroke	150mm* ¹	200mm 340mm	350mm 450mm		150mm* ²

*1 Clean specification: 120mm

*2 Clean and waterproof specification: 120mm

Controller Types

R/Q TYPE Controller

This controller is compatible with the “iQ Platform”, which seamlessly integrates the various controllers used in a production site with HMIs, the engineering environment and the network. It uses a multi-CPU configuration that dramatically improves its interaction with FA equipment and also offers highly precise control and fast yet simple information management.

[R TYPE controller]

MELSEC iQ-R series-dedicated

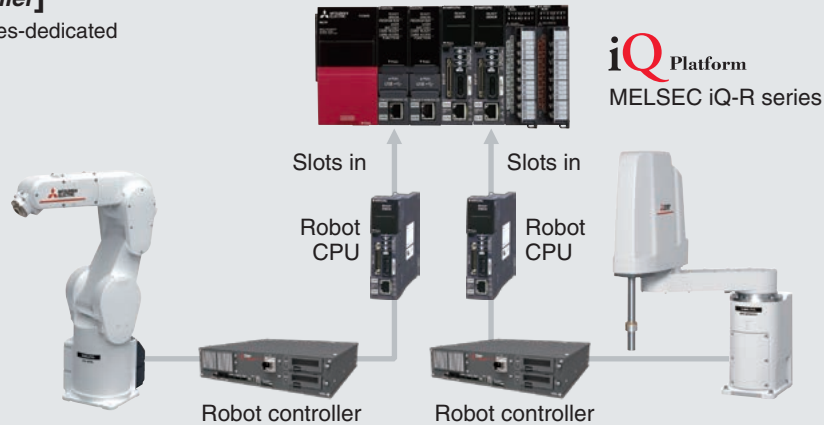

[Q TYPE controller]

MELSEC Q series-dedicated

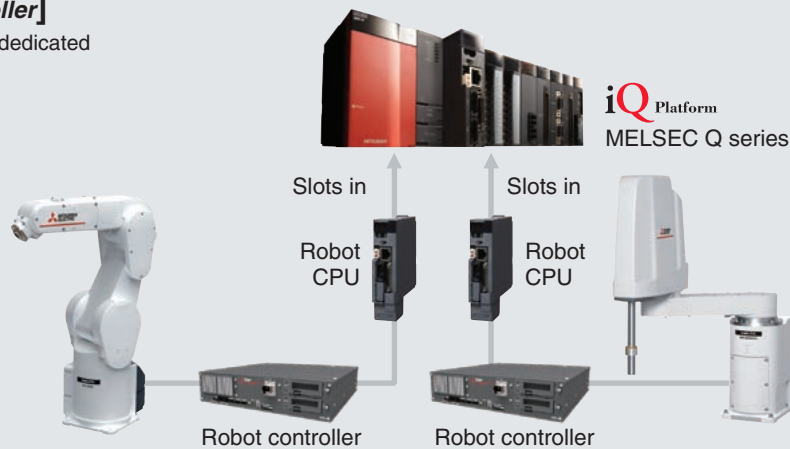

D TYPE Controller

A standalone controller similar to existing models. Enables the construction of cells using robot controllers as the control nucleus. Comes with various interfaces as standard, allowing customers to build a system optimized for their applications.

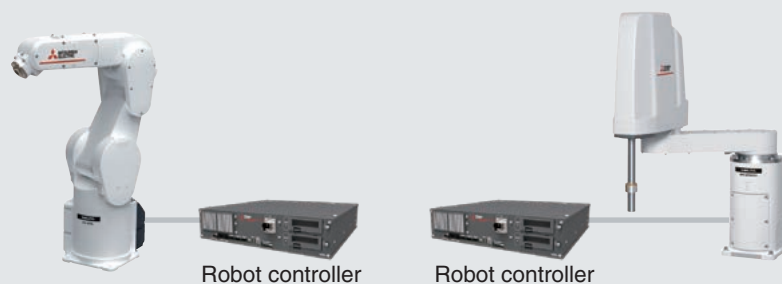

Improved controller performance

Control cycles on FR series controllers take just half the current time, improving robot control performance. The faster calculation speed gives better robot processing capacity and shorter cycle times for improved productivity. Integration with the various sensors also makes precision operation possible. (The performance of FR series Q type controller is equivalent to F series Q type controller.)



The R Type controllers supported by the MELSEC iQ-R series dramatically improve compatibility with FA equipment, allowing information to be shared mutually and data to be collected and processed. Improved system bus performance has also reduced communication cycles to 1/4 of current levels, allowing shorter cycle times for production facilities.

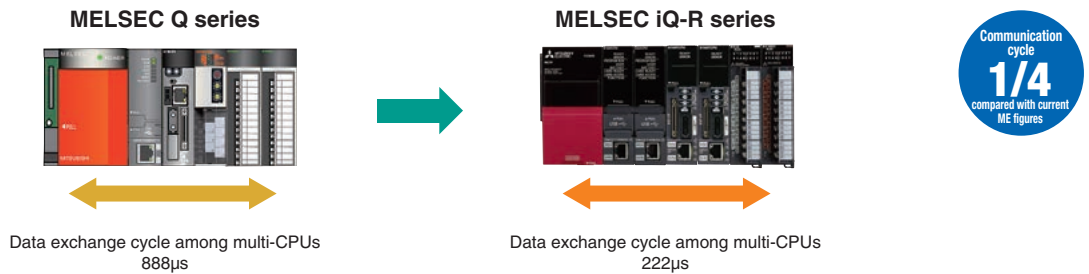

Dedicated motors for high-speed operation

Using motors developed in-house, highly rigid arms and our original drive control technology, these machines are capable of high-torque output at high rotation speeds, giving better operating performance. Their capacity for continuous operation is also improved, with higher productivity due to the shorter cycle times.

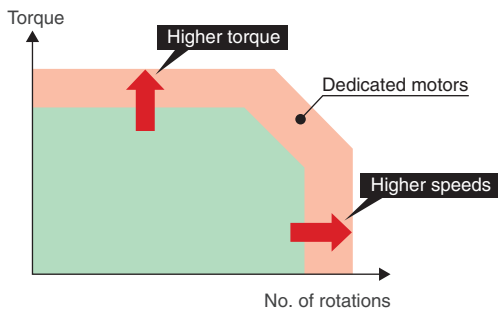

Expanded pivotal operating range

Improved flexibility for robot layout design considerations. Enabling more effective use of access space around the entire perimeter including to the rear. Shortened movement distances, enabling cycle times to be shortened.

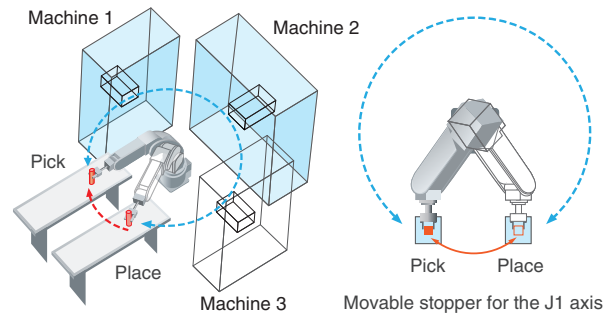

Preventing cable interference

Internal wiring channels provided in the tip axis. Allows wiring and tubes to be routed internally up to the gripper mount. By routing the body cables internally, areas where body cables might interfere with peripheral equipment can be minimized and the problem of wiring and tube tangles can be eliminated.

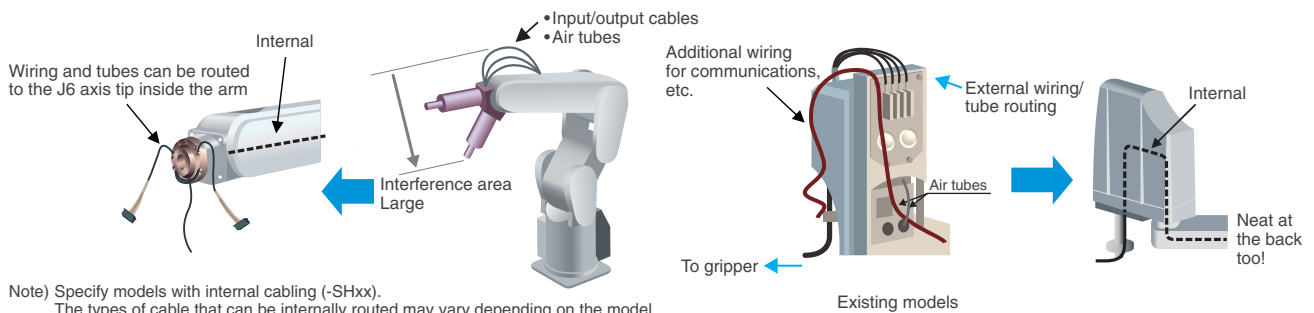

Note) Specify models with internal cabling (-SHxx).
The types of cable that can be internally routed may vary depending on the model.



Greater advances in intelligent technology

Enhanced cooperation with vision sensors and more advanced force sensors allow more advanced tasks to be accomplished at higher speeds and with greater precision.

Through the use of highly accurate vision sensors and force sensors that control the levels of force applied by robots, it is now possible to automate extremely difficult tasks that have been beyond the scope of automation in the past.

2

Functions

Force sensor

- Checks the applied force and the force status during insertion to provide improved work quality
- Assembly of difficult-to-fit workpieces
- Teaching assistance using force information
- Faster control cycles for improved force control

3D vision sensor

- Kitting or sorting of irregularly placed or overlapping workpieces
- Supports functions for easier startup

Preventing interference

iQ Platform

Checking for interference between the arms and grippers of adjacent robots prevents any contact.

2D vision sensor

- Setup tools for vision simplify the calibration of robots and cameras
- Simple Ethernet connections between robots and cameras
- Easy control using vision control instructions in the robot programs

Cooperative control

iQ Platform

- Two robots can be coordinated to transport very long or heavy objects
- Positional relationships of non-fixed parts maintained during transportation and assembly

Multi-function gripper

- Multi-function electric grippers capable of working with different part types of varying sizes
- Less need for setup changes

Example of intelligent technology use

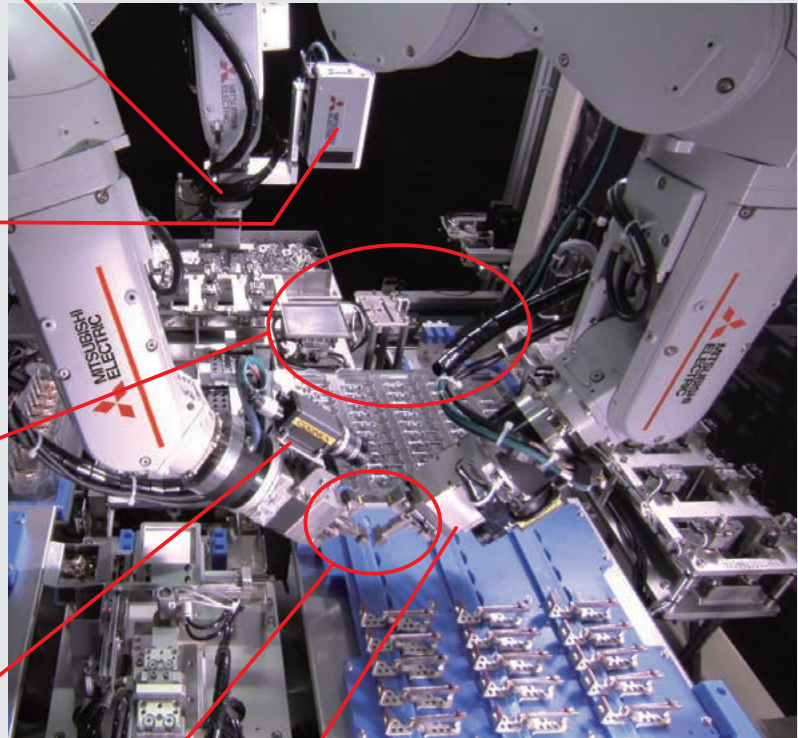

Tracking

Transport, alignment, and assembly work, etc. can be performed while robots are tracked with the workpiece on the conveyor without stopping the conveyor

Tracking accuracy enhancement function

Positional gain is changed in real time for even better tracking accuracy

Other functions

Singular point transit and orthogonal compliance functions facilitate the completion of a range of different tasks.



MELFA Smart Plus supports cell production, using robots to overcome the limitations on lead times, production volumes and location.

MELFA Smart Plus

Advanced intelligent functions are provided in the form of a function expansion option card. This provides leading-edge functions for all phases of customer's operations, from design and startup through to operation and maintenance. The functions provided include integration functions for the various sensors and autonomous startup adjustment functions.

*Activated with the insertion of a Smart Plus card.

CR800 Controller



MELFA Smart Plus card (2F-DQ5XX)



The high-precision technologies and calibration functions provided by MELFA Smart Plus allow correction of machine deviations between cells, offline teaching and copy cells*1. This then enables coordinated operation between the master cell and other cells.

*1 Offline teaching: Operation where programs created in a simulation are transferred to an actual cell.
Copy cell: Conveys master cell modification information. Processes in cells in other locations are then modified in the same way.

MELFA Smart Plus

Robot mechanism temperature compensation function

Improves positioning accuracy by compensating for thermal expansion in the robot arm

Calibration assistance function

Automatic calibration
Improves positioning accuracy by automatically correcting the vision sensor coordinates

Workpiece coordinate calibration
Improves positioning accuracy by automatically correcting the robot coordinates and workpiece coordinates from the vision sensor

Inter-robot relational calibration
Uses vision sensors to automatically adjust the robot location relative to other robots. Improves positioning accuracy during coordinated operation

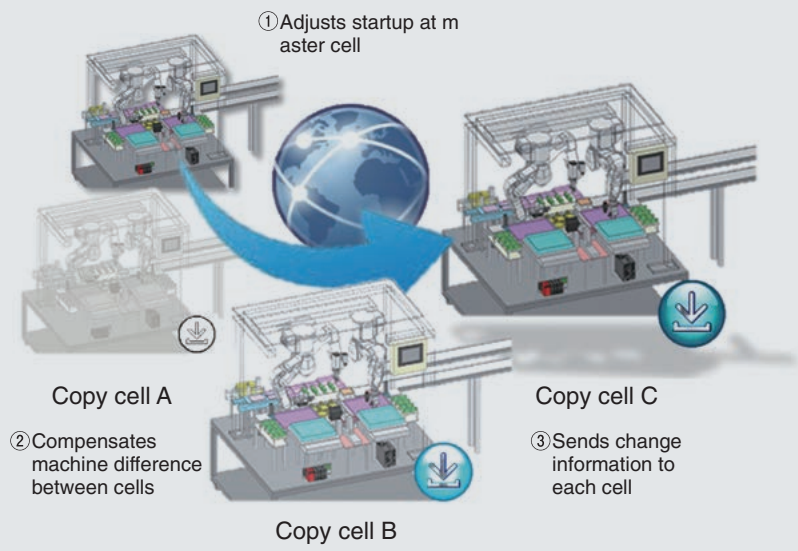

3D vision AI NEW

Shortens startup time by using original AI technology to automatically adjust parameters

Preventive maintenance NEW

Maintains the robot's health with operation status tracking

Coordinated control for additional axes

Integrates the robot and traveler for machining or assembly at a specified speed



Preventive Maintenance screen (RT ToolBox3)

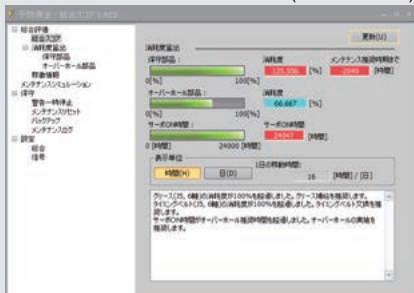

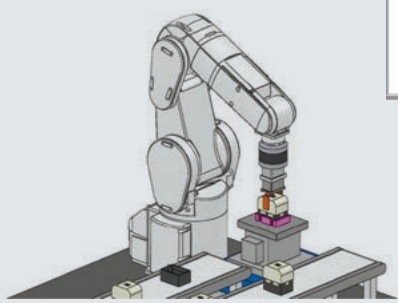



Greater advances in intelligent technology

Force sensor

See P.67 for detailed specifications →

Monitors the force applied to the robot gripper so that copying and fitting work can be carried out as it would by a human operator.

Force control

Controls “force” and “flexibility”.
Modifies control properties during operation.

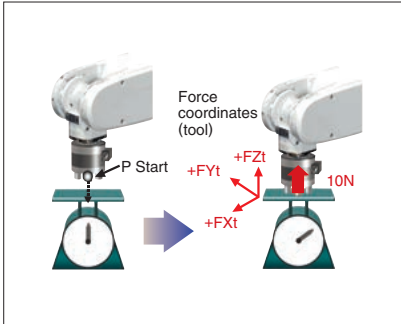

Keeps the force constant so that the workpiece can be handled without causing damage

Force detection

Switches operation in response to transitional states.

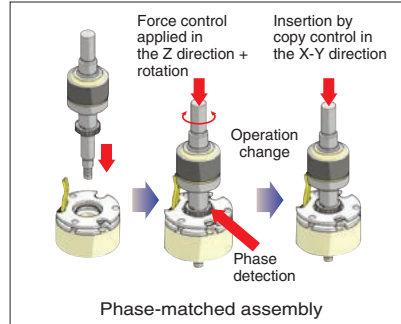

Complex assembly tasks achieved through techniques such as phase matching

Force log

Checks the work status.
Saves log data.

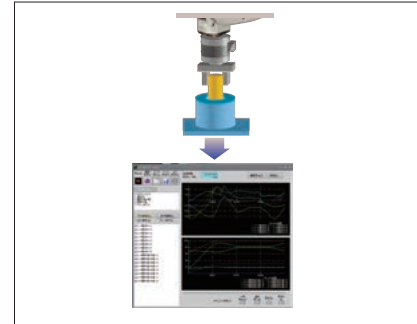

Checks the work status to facilitate adjustment.
Log data analysis also allows predictive safety measures

More accurate force sensor

Advances in force sensors allow faster and more accurate testing.

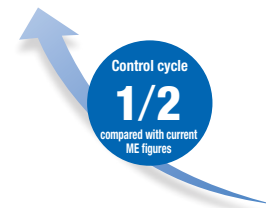

Gravitational offset cancellation

Compensates for gravity in response to changes in force on the force sensor in the X, Y and Z directions when the attitude changes.
Force control can be exercised correctly even when the attitude changes.

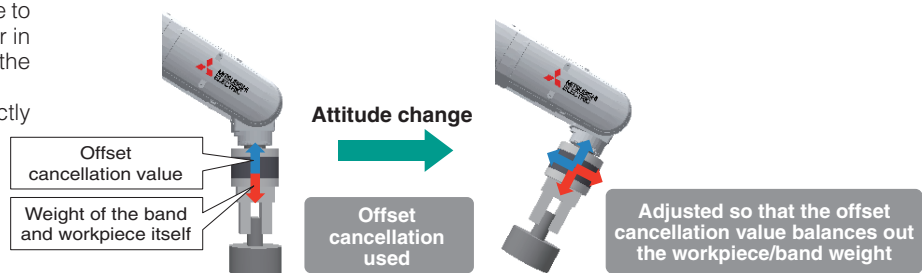

Teaching work assistance

Force GUI included **

- Computer software (RT ToolBox3) and a teaching box (R56TB or R32TB) are standard features of the force GUI screen, making it easy to use force sensors.
- Teaching can be carried out while monitoring the reactive force on the force GUI screen.

- Force data synchronized to the positional data can be saved as log data.
- Log data can be viewed as graphs using RT ToolBox.
- Log data files can be downloaded to a computer via FTP.

**1 GUI: Graphical User Interface

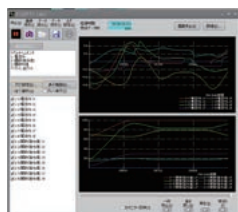

■ Force log (RT ToolBox3 log viewer)



R32TB

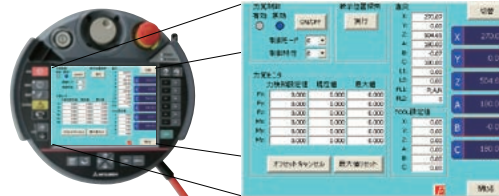

R56TB

Teaching while monitoring force states using the dedicated force control screen in the teaching box. Enables optimized location teaching

Assembly work (case study)

Fitting a coupling onto a spindle (insertion task with H7h7 tolerance)

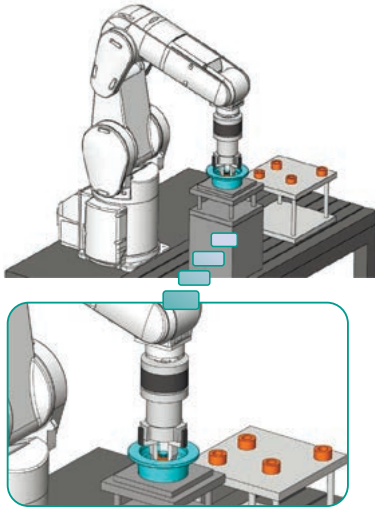

Key Points!

- Insertion is by fitting along the Z axis in the soft state while rotating in the θ axis direction.
- Force is specified where both are aligned on the same axis.
- Once they are aligned on the same axis, operation switches to positional control mode and the parts are assembled into their installed positions.
- The parameters required for this work can be set freely.

Operation overview

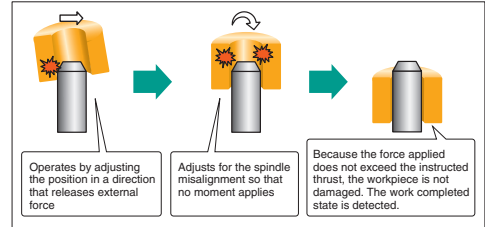

Related case studies

D-cut part insertion work

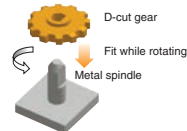

Insert to assemble by matching the gear phase to the D-cut spindle (10mm dia.)

Gear assembly work

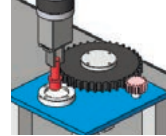

Assembly by meshing a flat gear and pinion gear

Bearing insertion work

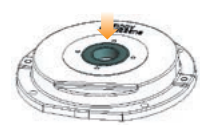

Insertion of bearing

Force inspection (case study)

Fitting of a part where the force must be managed and the spring pressure inspected

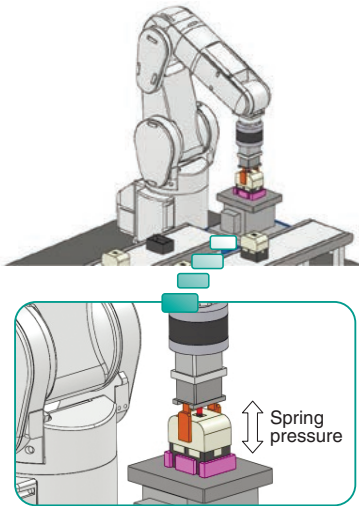

Key Points!

- The fitting assembly and spring pressure inspection are carried out on one machine.
- Force is inspected at the fitting operation stop position.
- The spring pressure is inspected in the force log.
- Productivity is improved due to assembly reliability and automatic testing.

Spring pressure inspection waveform

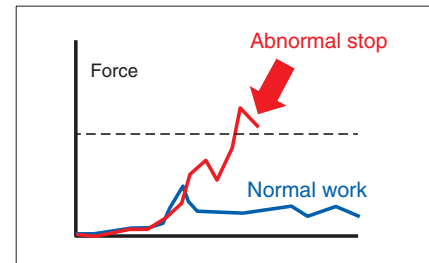

Related case studies

Spindle size inspection

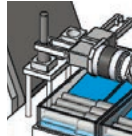

A spindle workpiece is inserted into a gauge to inspect the size

Snap mechanism part assembly work

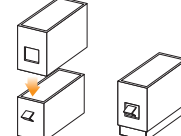

Measures variations in the pressure on the snap mechanism part and assembles the part with the correct force

Transportation (case study)

Belt transportation and installation on a pulley

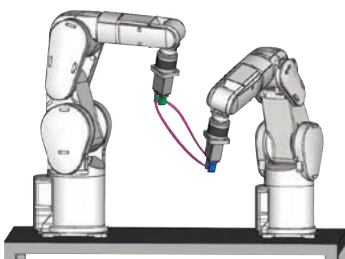

Key Points!

- The belt is transported using force control and coordinated work.
- Quality is assured without applying load to the workpiece.
- Suitable for work to install belts on pulleys using force detection.

Deburring and polishing (case study)

Deburring work on machines and plastic parts

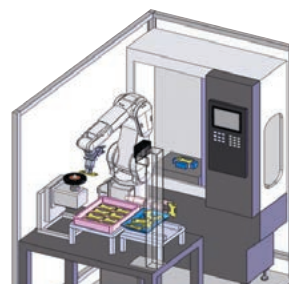

Key Points!

- Force detection and force control are used to deburr curved surfaces on mold parts.
- Achieves smooth machining without causing unevenness in the part's machined surfaces.



Greater advances in intelligent technology

3D vision sensor

See P.68 for detailed specifications →

Enables bulk feeding

Because the sensors allow bulk feeding without the use of special trays or parts feeders, it reduces the amount of part feeding work.

High-speed picking using original technology NEW

Shortens the image recognition time with high-speed recognition technology. (28% increase compared to Mitsubishi conventional model) Either the model-less recognition, which enables high-speed picking, or the model-matching recognition method, which accurately matches the workpiece position and attitude, can be selected to suit the application.

Recognition parameter automatic adjustment AI NEW



Mitsubishi's original AI technology and simulation technology automate the sensor parameter adjustment work, which requires expertise knowledge. Anyone can easily achieve the same performance as a skilled worker in a short time. (Compatible only with model-less recognition)

Lightweight and compact for diverse installation

Compact and lightweight sensor section enables installation on robot hand. Both eye-in-hand and fixed installation applications are supported. The work distance and range of view can be changed flexibly by using the enclosed base set or extended option vision.

Adjustment assistance function

Features functions to compensate for lens distortion and for the aperture size and focusing during focus and aperture adjustment. This makes adjustment easier.

Workpiece supply assistance function NEW

Spindle characteristic mode and attitude output mode can be used to ensure a stable grip during model-less recognition. **The function to estimate the remaining bulk workpiece level** allows the operator to understand the timing to load supplied parts.



MELFA-3D Vision

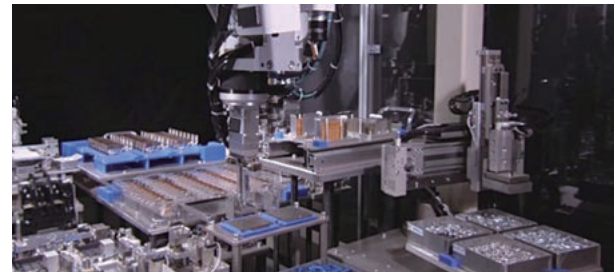

Bulk parts supply

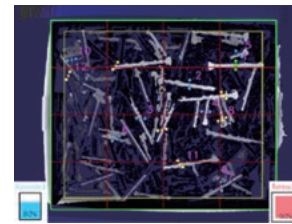

Model-less recognition



Model-matching recognition

Basic performance improved NEW

The grip position recognition speed has been greatly improved by reviewing the operation process method and connecting with a high-performance PC (general-purpose IPC). High-speed picking is now possible.

Conventional

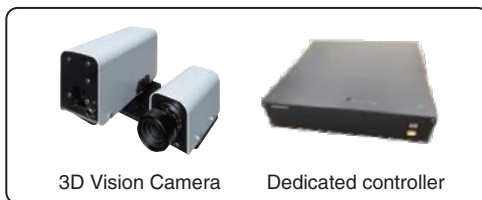

NEW

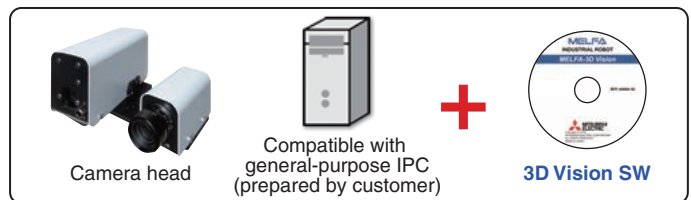

Recognition parameter setting AI function NEW MELFA Smart Plus

AI automatically adjusts the optimum 3D sensor parameters (image processing parameters, grip position recognition parameters) in a virtual space. Adjustment of complicated parameters is simplified by using the 3D CAD data, even without the camera head. This greatly reduces the vision sensor parameter adjustment time.

Features

- AI automatically adjusts parameters on PC
- No need for expertise knowledge

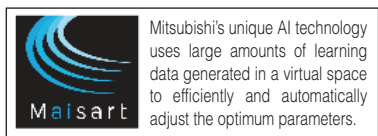

3D information on parts

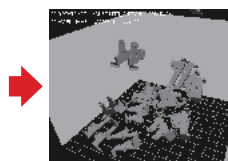

Bulk parts supply state is repeated with physical simulation



3D sensor simulation repeats parts measurement and recognition



AI automatically adjusts sensor parameters

Multi-function electric gripper

See P.71 for detailed specifications →

High-functioning operation control not possible using air cylinders

The gripping force and speed can be specified to suit the target, whether it's a heavy object or involves delicate work. Even when handling multiple workpieces of varying sizes, the operating positions can be specified so that the optimum stroke is configured. Product inspections can be informed by positional feedback from the gripper, such as whether gripping was successful or whether workpiece measurements indicate that it is acceptable.



● Multi-function electric gripper (TAIYO)

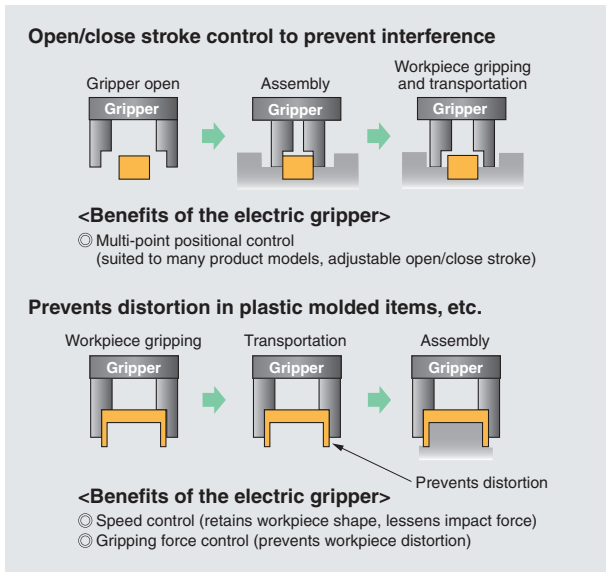

Simple control

The operation stroke and grip force can easily be configured for the workpiece shape using the robot programming.



Easy operation

The gripper can be freely controlled from the dedicated gripper screen in the teaching box.

Interference prevention function



Automatically prevents collisions between robots

Unanticipated interference can be prevented during jogging or automatic operation because collisions between robots are detected in advance and robot movement is stopped.

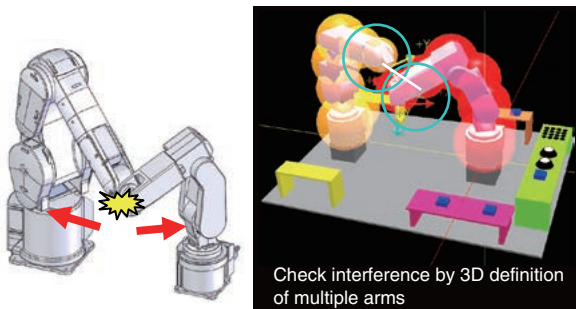

Reduced workload during startup

The number of recovery processes following collisions due to missed interlocks or teaching errors can be reduced.

Cooperative control



Cooperative control using multiple arms

Cooperative control between multiple robots is enabled through CPU connection between the robots. Normal operation is through individual robot operation, making operation simple.



Assembly work that maintains the relative positions for mutual gripping

Coordinated transportation

Long or flexible objects can be transported using multiple small robots instead of larger robots.



Greater advances in intelligent technology

2

Functions

Tracking

- Transport, alignment, and installation work, etc. can be performed while a robot is tracking workpieces on the conveyor without stopping the conveyor.
- Different variations can be selected, including vision tracking in combination with a vision sensor, tracking in combination with an opto-electronic sensor, etc.
- Programs can be created easily in robot language (MELFA BASIC).
- Standard interface function. (Separate encoder and vision sensor required.)

- No need for a positioning device
- Reduce cycle time
- Reduce system costs

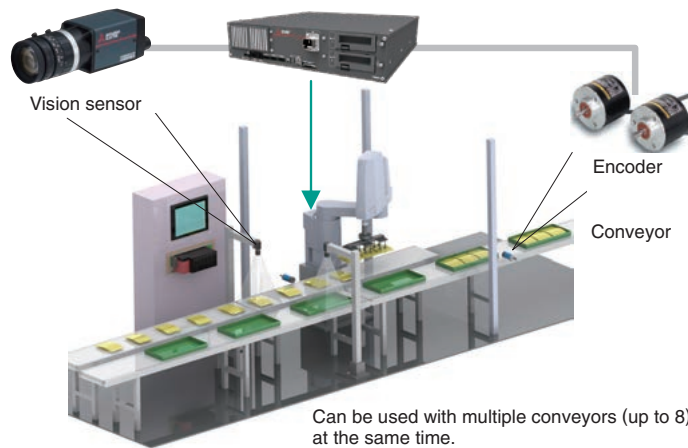

Additional axis function

- The layout can be set up to include the robot traveling axis and turntable as well as user machines separate from the robot such as loaders and positioning devices.
- Up to 8 additional axes can be controlled excluding the robot.
- Additional axes and user machines can be operated from the robot teaching pendant without any additional motion control hardware. The same JOG operation as for the robot can be used. Robot language can be used for control operations.
- The robot controller has compatibility with the MELSERVO (MR-J4-B, MR-J3-BS) servos.
- Standard interface function (Separate servo amplifier and servo motor required.)

- No need for a dedicated control device

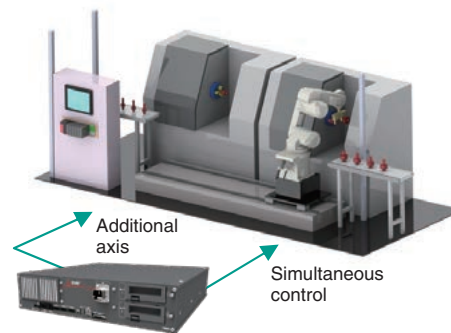
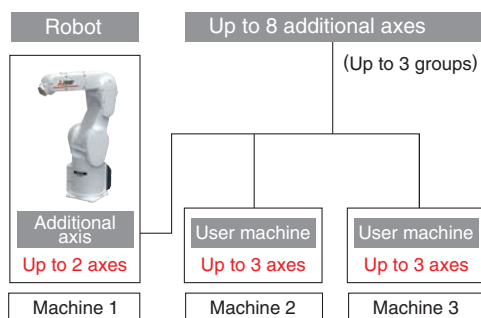

Improved accuracy

Active gain control

- Optimal motor control tuning set automatically based on robot operating position, posture, and load conditions.
- Improves tracking accuracy for the target trajectory.

• Active gain control is a control method that allows the position gain to be changed in real time.
 • This is effective when traveling straight and sealing work requiring high accuracy.

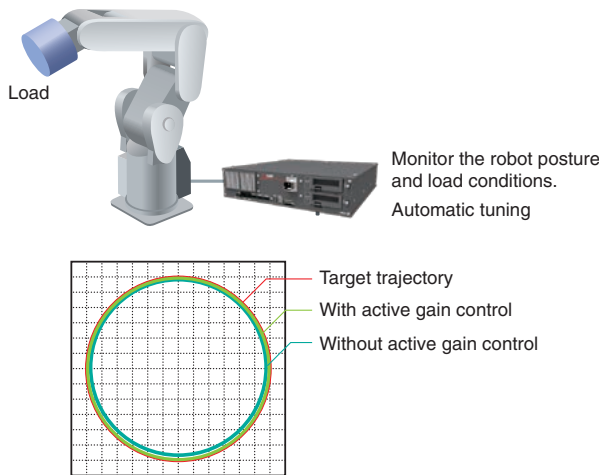

Operating mode setting function

- Trajectory priority mode/speed priority operation can be set in programs to match customer system requirements.
- Optimal motor control tuning set automatically based on robot operating position, posture, and load conditions.
- Improves tracking accuracy for the target trajectory.
- This is effective when traveling straight and sealing work requiring high accuracy.

- Improve trajectory accuracy
- Improve vibration-damping performance

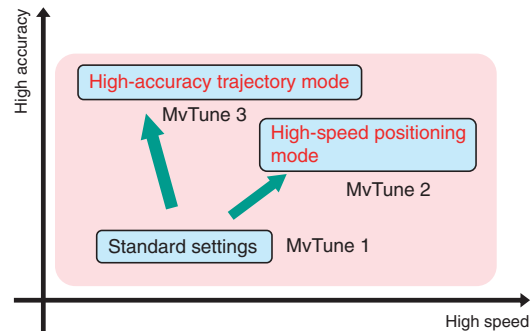

Other functions

Function for passing through the singular point

- The robot can be made to pass through the singular point. This allows for greater flexibility in the layout of robots and surrounding areas.
- Teaching operations can be performed more easily as there is no longer any need to cancel operations due to the presence of the singular point.

What a singular point is:
 There is an unlimited number of angles at which the J4 and J6 axes can be set such that the angle of the J5 axis is 0° when linear interpolation operations are performed using position data from a joint coordinate system. This point is the singular point and is the point at which the robot cannot be operated at an assigned position and posture under normal conditions. The position at which this occurs is referred to as a singular point.

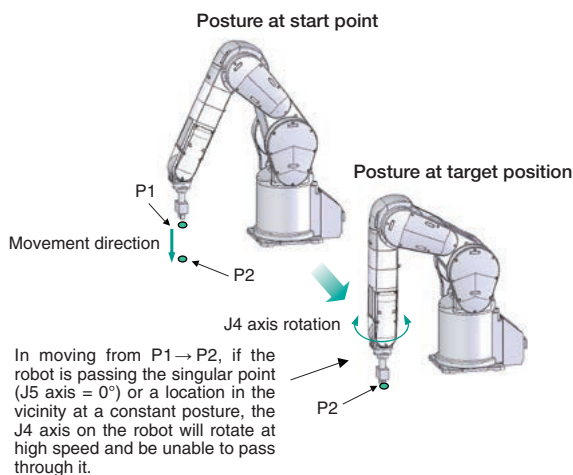

Orthogonal compliance control

- This function reduces the rigidity of the robot arm and tracks external forces. The robot itself is equipped with a compliance function, which makes special grippers and sensors unnecessary.
- This allows the amount of force generated through interference during chucking and workpiece insertion to be reduced and external movement copying forces to be controlled.
- The compliance direction can be set arbitrarily using the robot coordinate system, the tool coordinate system, etc.
- This is useful in protecting against workpiece interference and cutting down on stoppage.

- Reduce tooling costs
- Shorten line stop times
- Shorten startup times

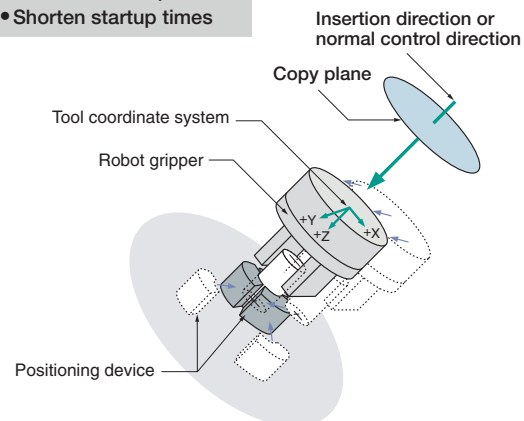



Greater advances in intelligent technology

Robot mechanism temperature compensation function

- Monitors the robot arm temperature and automatically compensates for deviations caused by thermal expansion in the arm.
 - Positional errors due to thermal expansion in the arm when seasonal or time-period-related temperature changes arise are reduced to 1/5th* of previous levels.
(Under Mitsubishi Electric measurement conditions)
- *It may change depends on models and environment around the robot.

MELFA
Smart Plus

2

Functions

Range error relative to start position

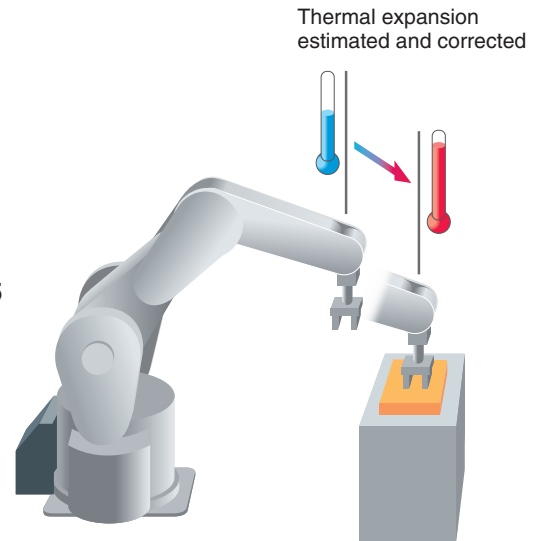
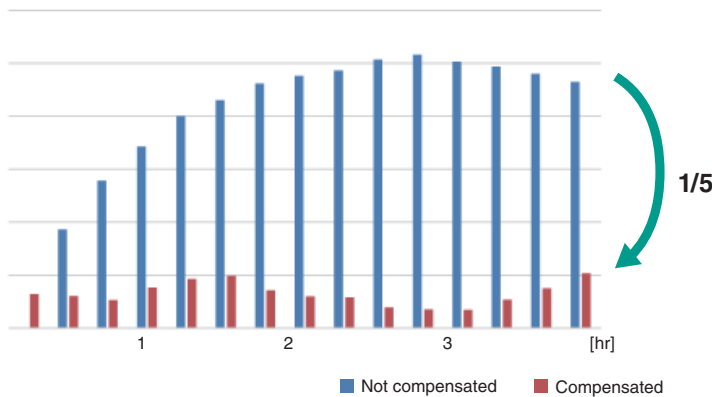

Coordinated control for additional axes

- Allows synchronized operation where a robot is installed on an additional axis (linear axis) and its speed relative to the workpiece is specified.
- Supports machining of large workpieces using linear, circular or spline interpolation that exceeds the robot's range of movement.

MELFA
Smart Plus

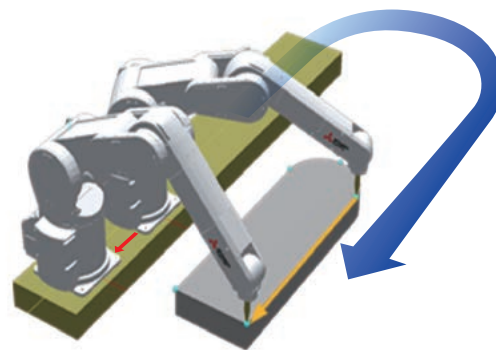

- Allows synchronized operation where tracking of the robot and workpieces on an additional axis (linear axis) is specified.
- Linear or circular interpolation while the workpiece is being transported allows operations such as precision sealing work and surface inspections.

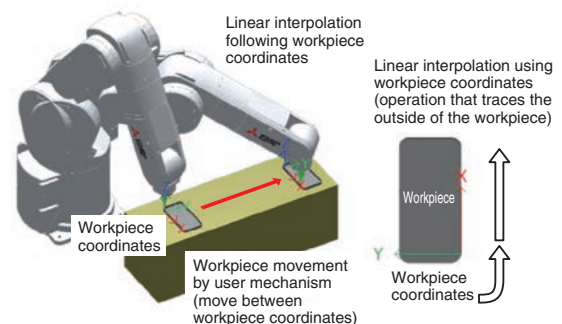

Calibration assistance function

Automatic calibration

Commands for calibrating the robot and 2D vision are included. This automates the teaching work required for existing calibration and allows calibration to be conducted using robot programs. A function is also provided that uses screen deviation to compensate for vision sensor mounting error, ensuring more accurate calibration.

MELFA
Smart Plus

	Current method (manual)	Automatic calibration
Working time (minutes)	20	1
Calibration accuracy (mm)	±0.2	±0.05

(Mitsubishi Electric measurements)

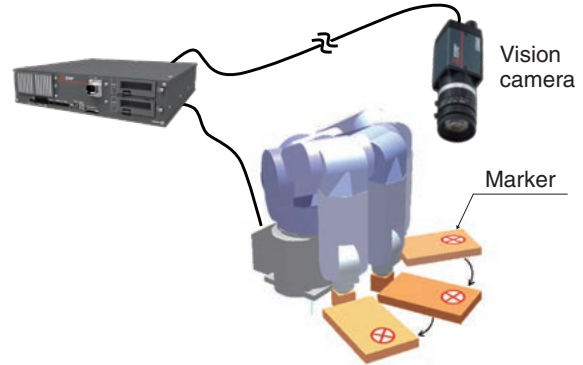

Workpiece coordinate calibration

Features 2D vision sensors mounted on the robot gripper and commands that calibrate work coordinates defined on the work palette, automating the teaching work required for existing calibration and allowing calibration to be conducted using robot programs. This simplifies tasks such the calibration of work palettes and robots installed on dollies or automated guided vehicles (AGVs).

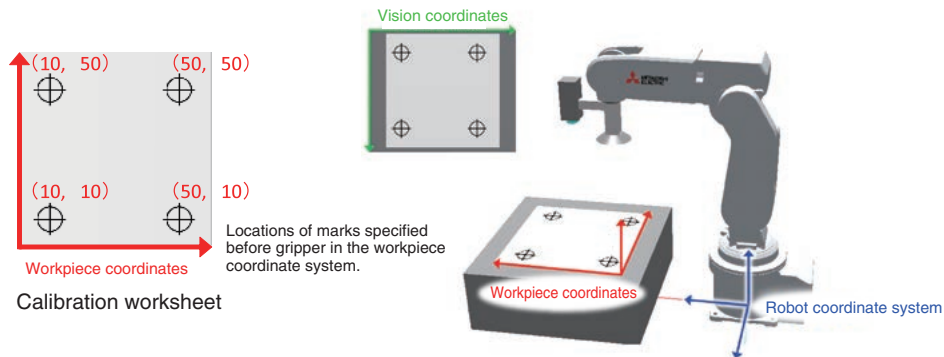

Inter-robot relational calibration

Coordinated work can be simplified by running robot programs to calibrate workpiece coordinates that are shared among multiple robots fitted with 2D vision sensors on their grippers.





Preventive Maintenance

Preventive maintenance function NEW

MELFA
Smart Plus

Maintenance simulation

The maintenance component replacement timing and component overhaul maintenance timing are estimated. This estimated information can be used to review the maintenance cycle beforehand, and to verify operation to long-life of the robot.

Consumption degree calculation function

The wear degree of drive components (grease, timing belt, reduction gears, ball screw/ball spline, bearings) is estimated from the robot operation status.

Efficient maintenance is supported by notifying the maintenance timing (with dedicated signal outputs, warning outputs), and by deciding the maintenance priority, etc.

Support for building maintenance system

Various maintenance data can be used in the robot program, and can be output to an IT system or GOT. Smart Plus helps build a maintenance system suitable for your system.

2 Functions

RT ToolBox3 (Preventive Maintenance screen)

Displays state of component wear

Displays messages related to maintenance

Details screen for calculating wear degree

The grease (J4 axis) consumption degree exceeded the warning number of days remaining. Please check the details and prepare for grease supply.
The timing belt (J3, 4 axis) consumption degree exceeded the warning number of days remaining. Please check the details and prepare for timing belt replacement.
The grease (J5, 6 axis) consumption degree exceeded 100%. Grease supply is recommended.
The timing belt (J5, 6 axis) consumption degree exceeded 100%. Timing belt replacement is recommended.
The servo on time exceeded recommended overhaul time. Overhaul is recommended.

The robot status can be quickly checked on the Preventive Maintenance screen.

The wear degree of maintenance components and overhaul components is color-coded, so components needing replacement can be quickly identified.

Maintenance Simulation Details screen



The maintenance timing can be predicted with pre-operation simulation.

Wear degree calculation function

Streamlined maintenance matching the usage conditions is supported by “visualizing” the component’s wear degree.

Feature

See the wear degree of key components

Kinetic models and drive data are used to calculate the physical quantities (force, speed, etc..) applied on the target components (grease, timing belt, reduction gears, ball screw/ball spline, bearings).

The wear degree of each component is calculated by comparing these quantities with the component’s life expression.

Receive notice on the appropriate maintenance timing

“Warnings” and “general-purpose signal outputs” can be issued at the maintenance timing.

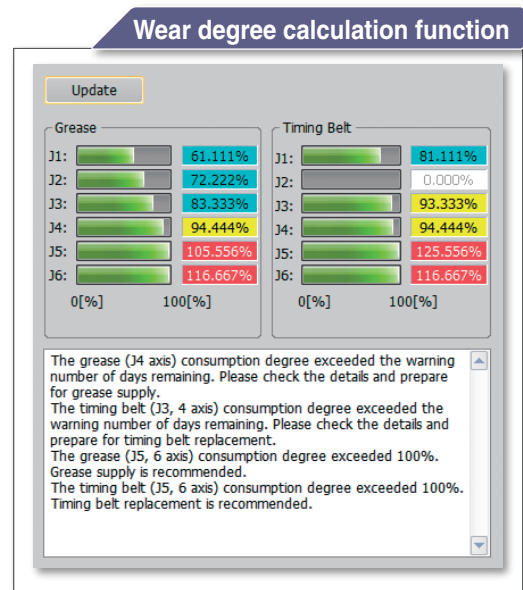

Maintenance simulation

Learn the robot maintenance timing before starting operations

Feature

Maintenance timing is estimated based on the operation

The maintenance timing is calculated estimating that the designated motion (range designated in robot program) is repeated.

Review of robot-friendly motion is supported

The robot life can be estimated with offline simulations. Operations can be verified while changing the operation program, while taking the cycle and life into consideration.

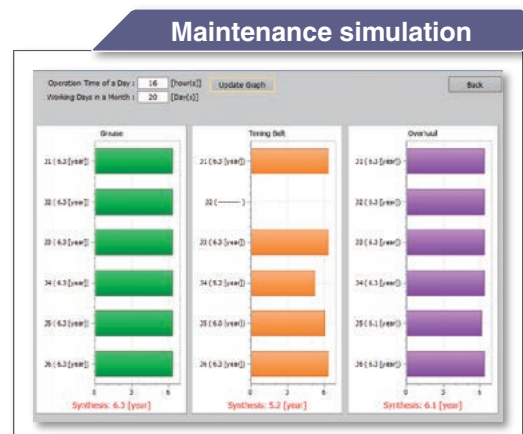

Coordination with host devices

Collectively manage the robot’s maintenance data with a host system

Feature

Supporting a diverse maintenance system configuration

The maintenance information is held as status variables. This maintenance data can be used in the robot program, and can be retrieved from a host device using communication middleware.

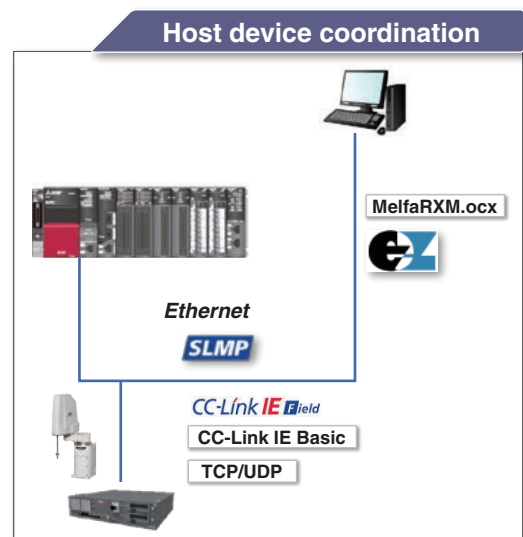



Enhanced cooperation with FA products

The seamless integration of machines enables flexible manufacturing tailored to the type of production. This improves productivity and maintainability and can reduce the TCO (Total Cost of Ownership).

2

Functions

iQ Platform

- Collaboration with MELSEC Q series/MELSEC iQ-R series realize more advanced work
- Shorter I/O processing times due to faster communication between CPUs
- PLC management allows large volumes of information to be sent to and from robots in real time
- Allows direct read/write operations to memory shared between robot CPUs

CC-Link IE Field/SLMP

Allows seamless data communication from production management down to the level of devices

GOT integration

- Provides easy recipe management through checking of robot operations and information, data collection and setup switching
- Integrates production site operations with the GOT for improved operation and maintainability

Maintenance

Information before and after errors occur (state changes, I/O, external system variables, etc.) and program run states can be saved as log data, simplifying error identification.

Easier robot information management

Data specific to robot mechanisms is recorded and saved inside the mechanisms, simplifying maintenance.

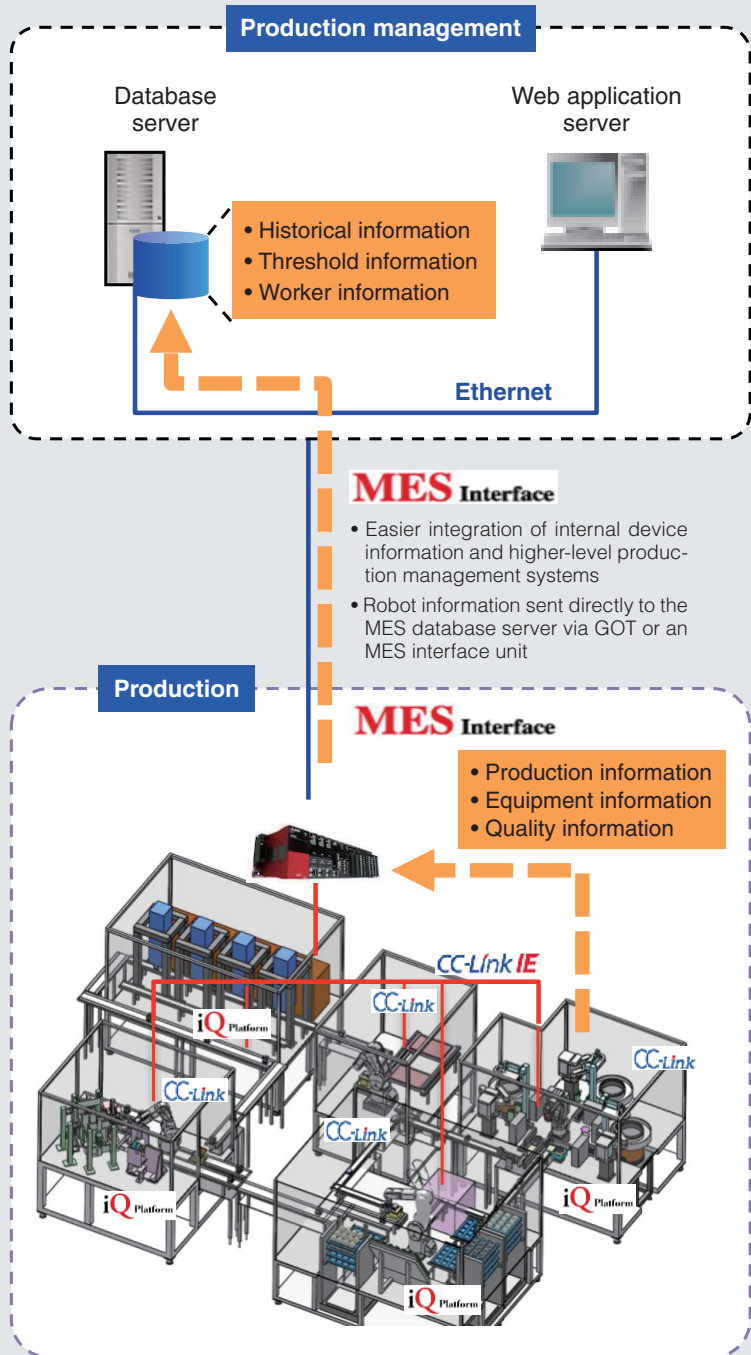

iQ Platform

Integration with the MELSEC iQ-R series PLCs enables more advanced tasks.

■ Better responsiveness due to faster communications

MELSEC Q Series



MELSEC iQ-R Series



Data exchange cycle among CPUs
888μs

Data exchange cycle among CPUs
222μs

Shorter I/O processing times due to faster CPU data communication

■ Large volumes of data



- Expanded shared memory area

PLC management allows large volumes of information to be sent to and from robots in real time.

■ Direct communication between CPU units



- Improved synchronization
- Less wasted time

Allows direct read/write operations to memory shared between robot CPUs. Less wasted time because large amounts of data can be shared.

Batch management of multiple robots

Robots on the PLC network can be accessed from a computer connected to the main CPU. Allows shorter startup times for robots on the production line and improved maintenance.

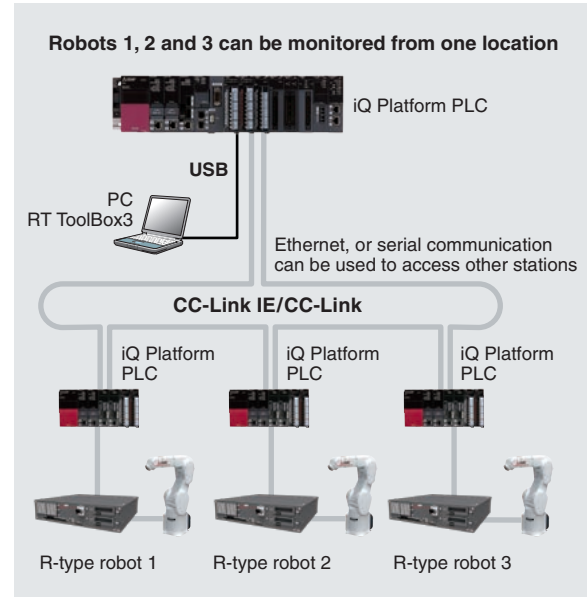

CC-Link IE Field/SLMP

- Compatible with CC-Link IE Field and SLMP.
- Allows seamless data communication system-wide, from the production management level down to the device level.
- Allows simple connection using just LAN cables.
- Enables general-purpose Ethernet devices compatible with SLMP (vision sensors, etc.) to be used with robot programs.
- Allows robot information (device information) to be collected from higher level devices.

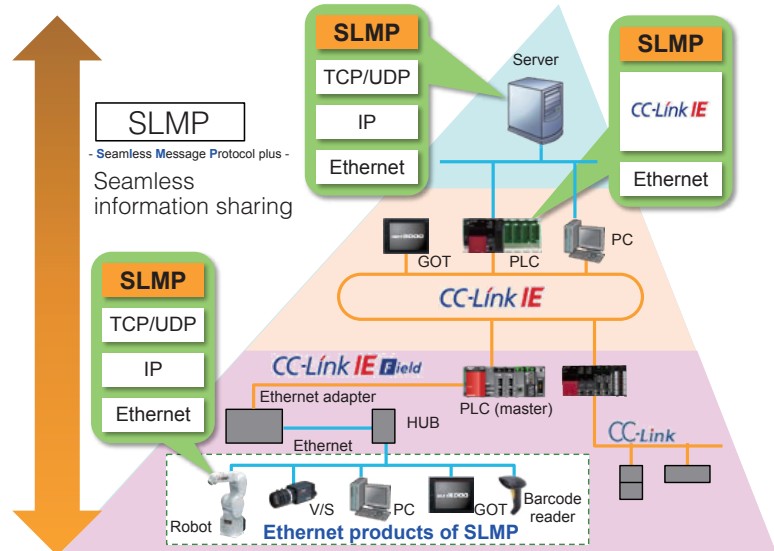

Various network options

The various network options allow connection to a variety of devices.

Standard equipment: Ethernet
USB
SSCNET III
Link IE Field Basic (Ver.A1d or later)

Option: CC-Link
Profibus
DeviceNet
Network base card (CC-Link IE Field EtherNet/IP, PROFINET, EtherCAT)



Enhanced cooperation with FA products

GOT integration

The GOT integration function makes it easy to use features such as recipe functions through setup switching, data collection and checking of robot operations and information. Production site HMIs can be integrated with GOT to help improve operation and maintainability.

GOT backup/restore functions

Data such as robot programs and parameters can be saved (backed up) onto the GOT SD card or USB memory stick using the GOT backup and restore function.

By backing up the GOT beforehand, operation can be restored with the GOT with no need for a personal computer (GT21 and higher). This greatly improves serviceability. The situation is saved even when an unexpected error occurs. This helps prevent data from being lost due to the empty battery or robot malfunction.



Device monitoring function

Allows the status of FA equipment such as PLCs, motion controllers, robot controllers and CNCs to be checked without a computer. Useful for tasks such as starting up devices.

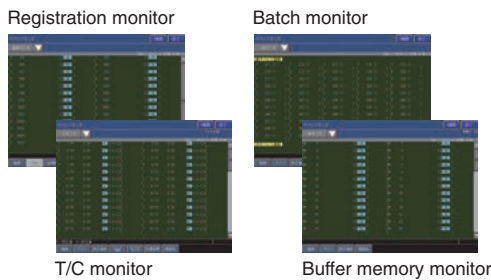

Logging & graphs list

Uses GOT to collect and display data from equipment such as PLCs and robots. Data can be checked in readily understandable graphs and lists, allowing early identification and analysis of the causes when faults occur.

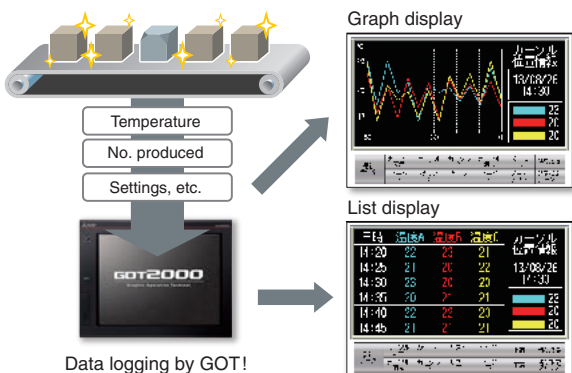

Shared memory expansion

Enhanced efficiency of monitoring and maintenance operations onsite using a single GOT (display device) as the Human Machine Interface (HMI).

Example of GOT display



Enables the robot to be controlled from the GOT even without a teaching box.

Current robot position data, error information, etc. can be displayed easily on the GOT.

Internal robot information

- Error, variable, and program information
- Robot status (Current speed, current position, etc.)
- Maintenance information (Remaining battery capacity, grease life, etc.)
- Servo data (Load factor, current values, etc.)

Sample image files can be downloaded from the Mitsubishi Electric FA website.

- Useful sample image files that can immediately be used in actual systems.
- Sample sequence programs (function blocks) are provided for using the sample image files.

(Note) The sample image files are for the GT27 (640 x 480 or better). To use the files, GT Designer3 Version 1.178L or later is required.

Recipe function

This enables you to store data for each product in GOT and then write only the required data to a PLC, which simplifies the process of changing the setup for very varied manufacturing lines.

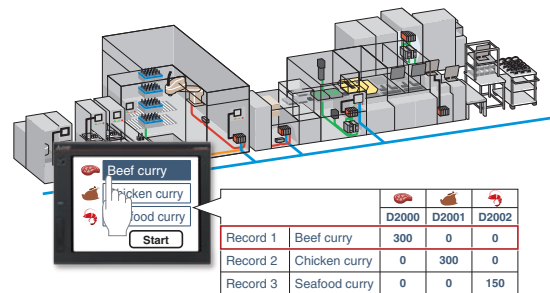

GOT connection (transparent function)

Programs and parameters can be edited from the USB interface on the front of the GOT using a transparent function for improved operability. (For GT21 or better)

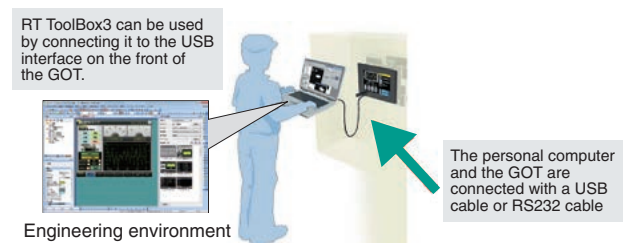

Support for the “e-F@ctory” FA integrated solution

Robot information can be sent to the MES database server using PLCs and MES interface units. The simple system construction allows you to obtain the robot production information (using the device allocation function).

Simple connection and integration of various types of FA devices (PLCs, GOT, servos, etc.). The GOT MES interface function can be used to integrate various types of information from FA devices, including robots, thereby improving productivity and maintainability.

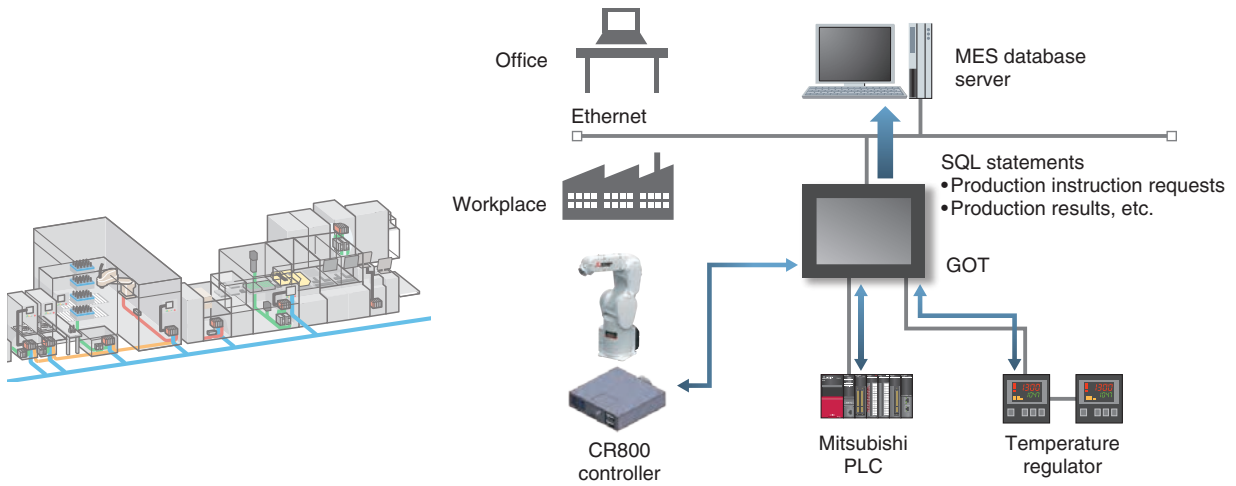

Maintenance (log function)

Robot information before and after an error occurs, and the program execution status can be automatically sent to the FTP server or saved on an SD card as log data. The operation log can also be retrieved, so causes of errors can be analyzed efficiently. (RT ToolBox3 is required.)

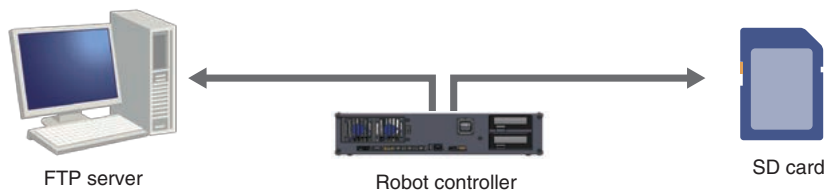

*It works only on FR series D type (CR800-D)

Easier robot information management

Memory is included in the robot body and used to store robot-specific information. This makes it easy to switch robot controllers. Information can also be collected without visiting the workplace, simplifying the formulation of maintenance plans.

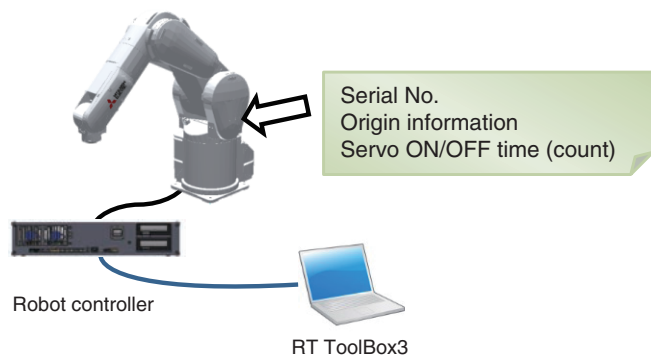



Improved safety through collaborative work applications

Safety functions ensure that automation is simpler, safer and more user-friendly.

Collaborative human-machine operation support that includes safety options allows working areas to be used jointly by people and robots.

This ensures that factories provide both productivity and flexibility.

*Customers must conduct risk assessments.

2

Functions

Safety monitoring function

Safety features are provided that make risk assessment easier.

Safe I/O

Supports safe system connection through duplicated safe I/O (8 inputs and 4 outputs)

Position monitoring function

- Monitors robot positions
- Monitors movement into designated areas (8 locations)

Speed monitoring function

- Monitors robot speeds
- Also capable of monitoring each of the speed components in the X, Y and Z directions for the monitoring point

Safety logic editing

Allows the working parameters (logic) of the safety monitoring function to be defined.

Collision detection function

Detects robot arm collisions as a standard function during teaching or operation. Minimizes damage to equipment such as robot arms, workpieces and grippers.

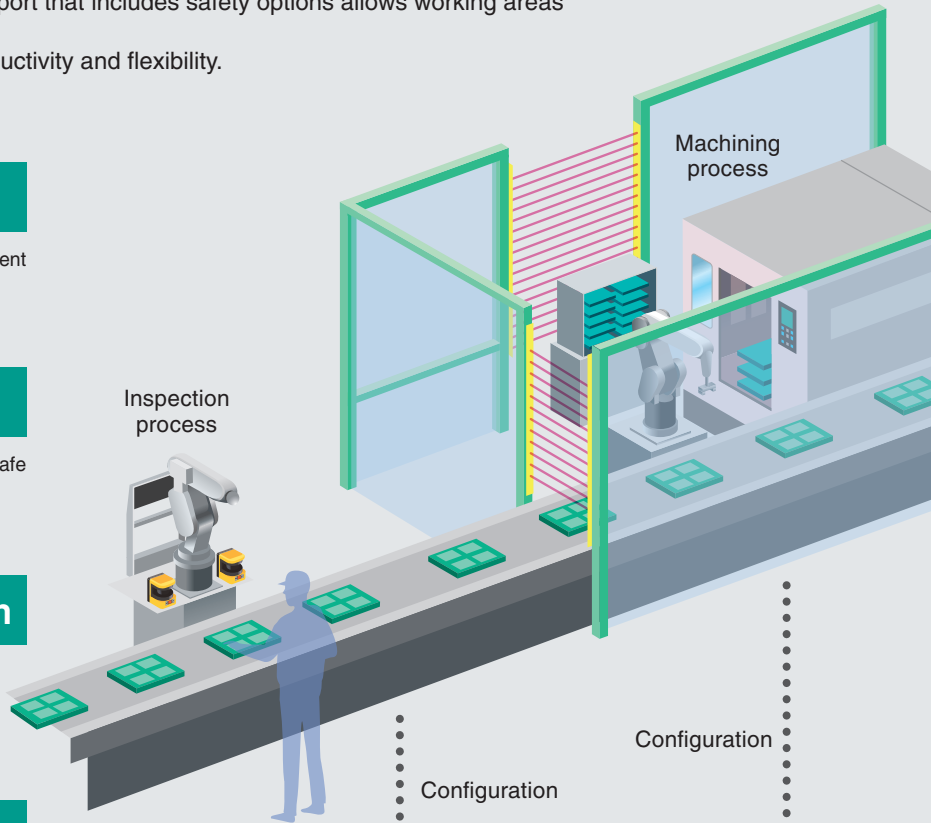

Sample system configuration

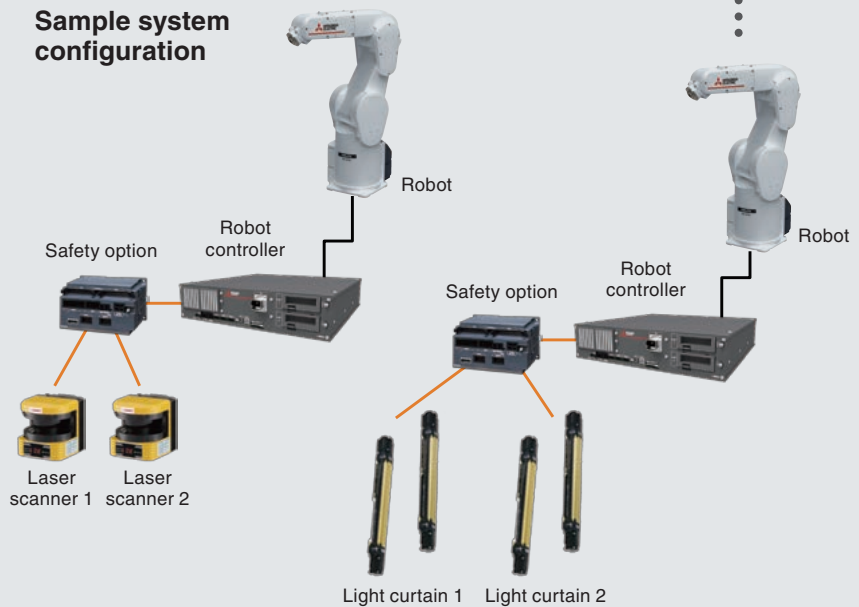

Safety option / Features

Operators can enter an operation area without stopping robots.

- **High safety compliant with international standards**
- **Robot's automatic operation continues even with a safety fence opened.**
The safety input function enables safety doors to open without causing an emergency stop of the robot.
- **Operators and robots share an operation area. = They can cooperate.**
While an operator is in a cooperative operation area, a robot does not approach the area. (Operation range limit function)
- **Robots in cooperative operation keeps the safety speed.**
A robot in cooperative operation continues its operation at the safety speed to secure operator's safety.
- **Robots can automatically shift to single operation from cooperative operation.**
Closing the safety door switches cooperative operation to single operation, and enables the robot to approach to the shared area.

*Risk assessment and safety level proof need to be performed for the system. Please contact us if you require any further information.

Examples of safety options

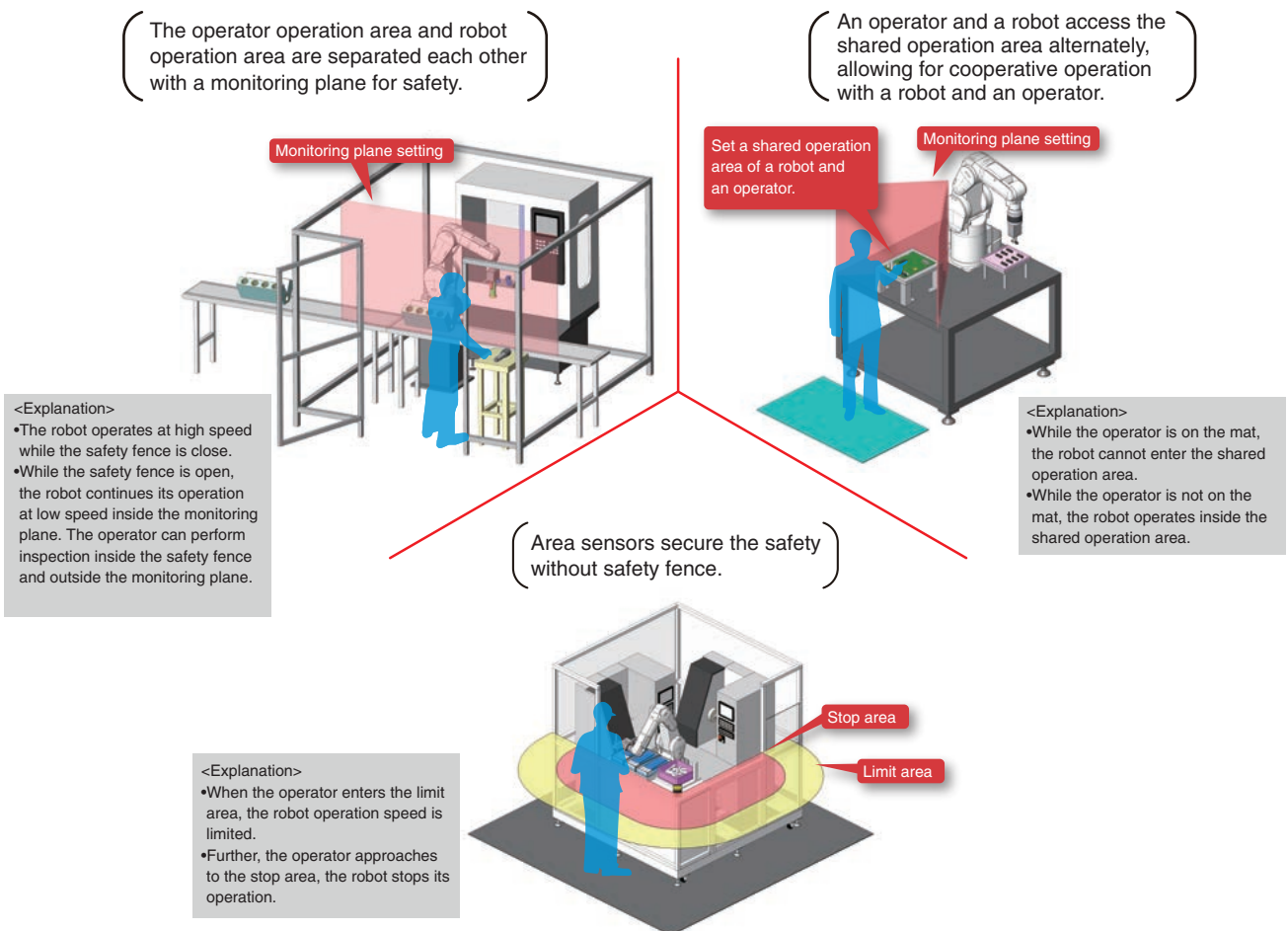



Improved safety through collaborative work applications

Safety monitoring function

Safety features compliant with the requirements of international standards are provided that make risk assessment easier.

Safety feature	Details	Comment	
STO function	Electrically shuts off power to the motors in the robot body	IEC 61800-5-2, category 4, PLe, SIL3*1	Supported as standard
SLS function	Monitors the TCP speed so that it does not exceed the monitoring speed.	EN61800-5-2-compliant	Supported in combination with each safety option
SLP function	Monitors a specified monitoring position so that it does not go beyond the position monitoring surface.	EN61800-5-2-compliant	
SOS function	Monitors the robot to ensure that it does not move from its stopped position	EN61800-5-2-compliant	
SS1 function	Function stopped by STO	IEC 60204-1 stop category 1	
SS2 function	Function stopped by the SOS	IEC 60204-1 stop category 2	

*1 Parameter setting is required.

Safe I/O

Expands duplicated safe I/O to 8 inputs and 4 outputs. Allows the construction of various different safety systems.

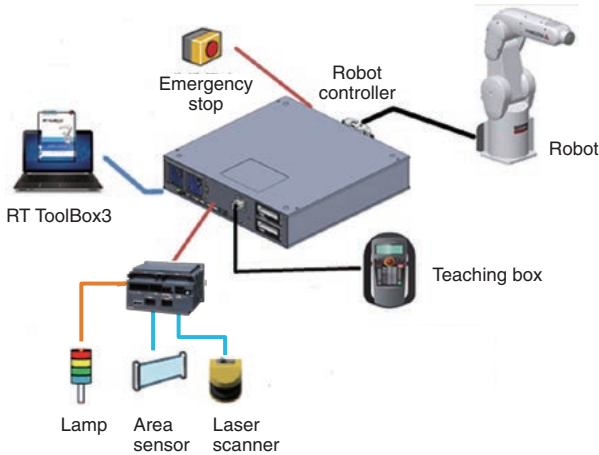

Position monitoring function

- Monitors robot positions.
- Monitors movement into designated areas in up to 8 locations.

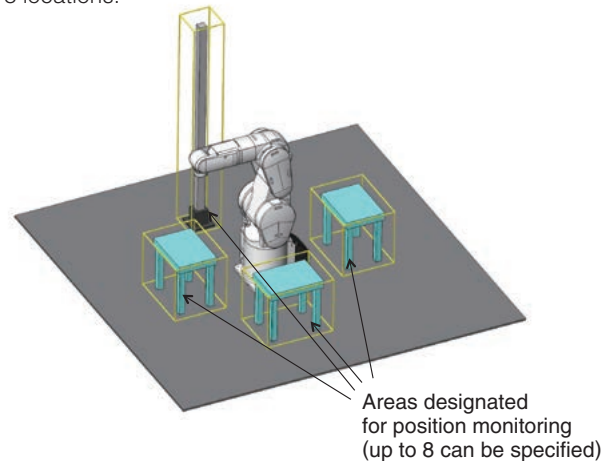

Speed monitoring function

- Monitors robot speeds
- Monitors designated monitoring points on the the robot arm and gripper to ensure that they do not exceed the monitoring speed.

- Also allows monitoring of each of the X-, Y- and Z-direction components for each monitoring point. By setting a low monitoring speed in the system for directions in which the robot does not move, safe distances can be made smaller to create compact cells safely.

Monitoring points: 4 locations on the robot arm



Monitoring points: 4 locations on the gripper

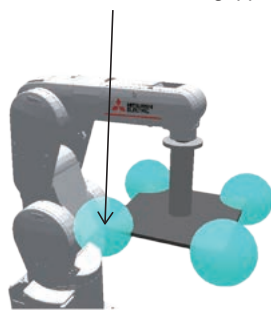

Without speed monitoring

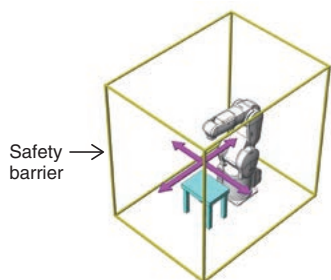

Robot movement direction/speed

With speed monitoring

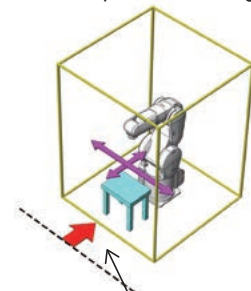

Low monitoring speed set for forward-backward robot movement → Small safe distance (more compact)

Safety logic editing

The logic for each safe I/O can be edited. Safety logic editing makes it easier to construct and operate safe systems. Because it allows you to freely define the operating parameters (logic) for the safety monitoring functions in the robot controller, you can configure the safety monitoring conditions without having to use a safety CPU.

By configuring the parameters in the editing screen, you can use various different types of monitoring. For example, in area monitoring, specified functions operate in response to the robot position, while in interlock monitoring, specified safety functions operate according to the the positions of other robots.

Usage scenarios

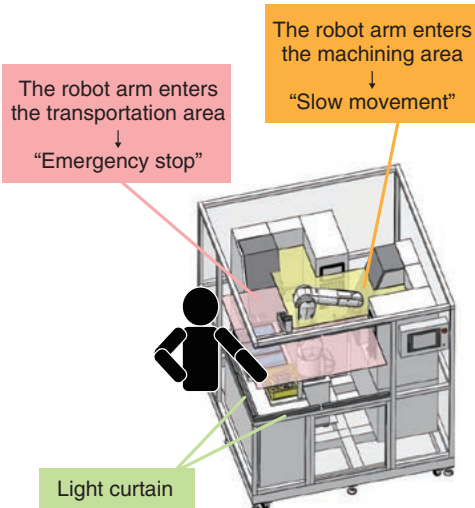

The screenshot shows the 'DSI 1:RC1 (オンライン)' safety logic editing screen. It features a table for configuring safety functions. Annotations include:

- Safe I/O:** Points to the DSI1-DSI8 rows.
- Position monitoring:** Points to the AREA1-AREA3 rows.
- Logic expression for safe I/O and position monitoring:** Points to the LOGIC section with AND/OR dropdowns.
- On/Off setting for each safety function:** Points to the columns SS1-SS2, SLS1-SLS3, SLSM, SLP1-SLP4.

Additional UI elements include '入力信号設定(P)', '動作チェック(O)', '安全機能パラメータ最終設定日時: 2017/04/11-00:00:00', and 'DSIフィルタ時間(S): 10 [ms]'.

Safety logic editing screen

Collision detection function (Standard feature)

Collision detection function

- This function detects if the arm collides with an obstacle while teaching or operating, and helps reduce damage to the robot arm and tools.
- The collision detection function can be used to protect the workpiece from becoming damaged due to interference between the workpiece and affected objects.
- The detection level can be changed according to the protection targets.
- Operation following collision detection can be programmed to suit the circumstances.
E.g.) Stop immediately and post an error; retract and then post an error, etc.

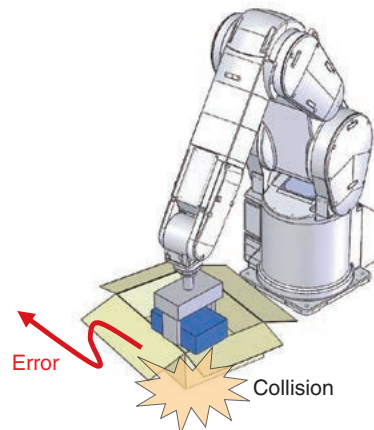

- Reduce tooling costs
- Shorten line stop times
- Reduce maintenance costs

Program Creation and Total Engineering Support Software

RT ToolBox3

This is computer software to assist with a range of tasks from system startup through to debugging and operation. This includes creating and editing programs, checking the operating environment prior to robot installation, estimating cycle times, debugging when robots are started up, monitoring robots states once they are running and monitoring faults.

Its features include a ribbon bar, output window and docking pane, making information easier to see and the software easier to use. Operations in the 3D monitor screen have also been updated to make using the screen more intuitive.

RT ToolBox3 mini	Simplified version. Offers programming, debugging, and monitoring functions.
RT ToolBox3	Includes simulation functions. May also be used for preliminary examinations.
RT ToolBox3 PRO	Runs on 3DCAD (SolidWorks). Allows even more realistic examinations. CAD data can also be used for path generation and operation programs.

2

Functions

Program editing and debugging

Auto-complete and fold functions make programming easier to use.

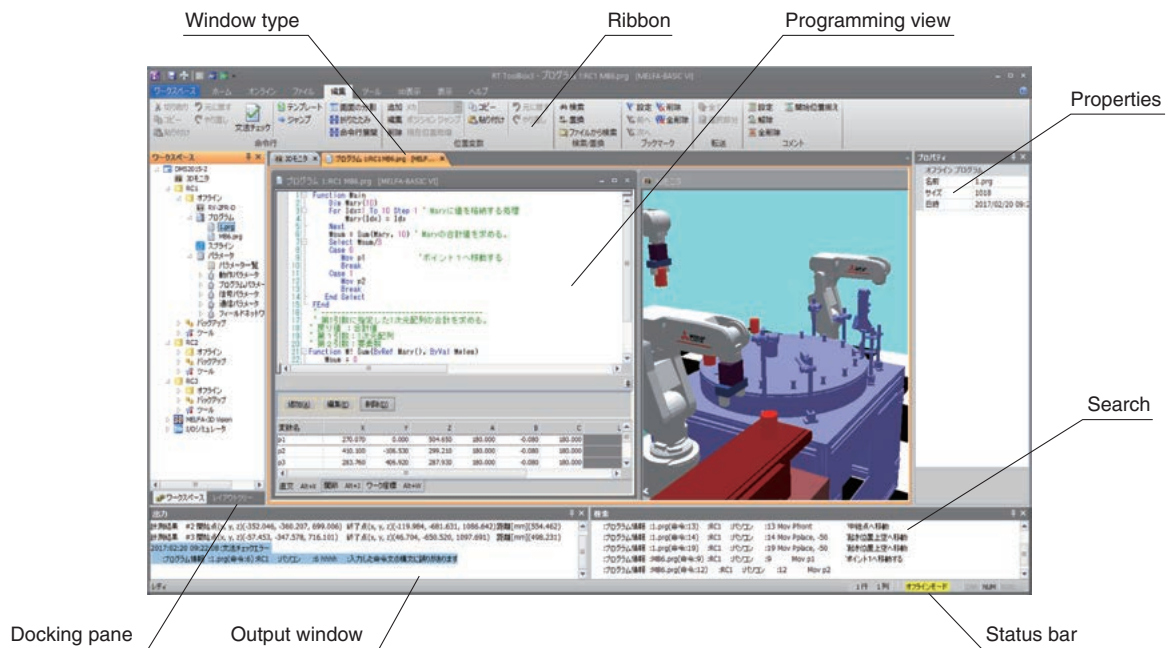

Simulation function

Simulation that includes features such as robot dynamics and servo responses as well as robot controller emulation allows realistic simulations that include motor loading, tracking and positioning times.

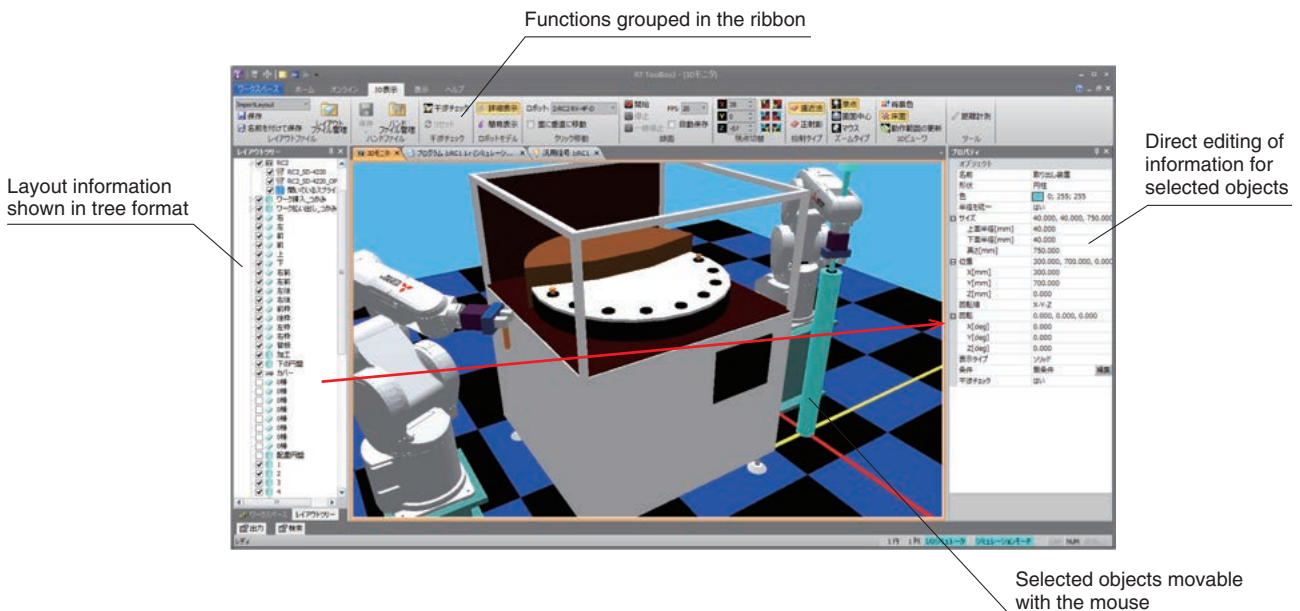

3D viewer

The 3D viewer can be used to check the robot attitude and operation and to visually check information such as limit values for user-defined areas, etc.

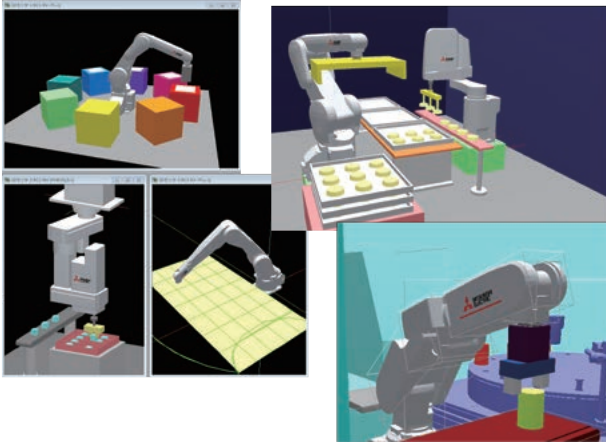

Real time external control

Robot movement can be controlled from the computer using synchronous units.

Melfa RXM.ocx communications middleware

Allows RT ToolBox functions to be run from computer applications.



MELFA BASIC VI

As well as providing a more complete set of commands, this uses structured programming to give high levels of reusability and readability.

Structured programming

Allows structured programs, enabling programming with high levels of reusability and readability. (Also supports existing programming methods.)

```

1 Function Main                                'Entry point
2   MResult = FnMMove(P1, P2)
3   MResult = FnMMove(P3, P4)
4 FEnd
5
6 Function FnMMove(P1, P2)                    'User function
7   Mov P1
8   Mov P2
9   Return 1
10 FEnd
    
```

Diagram showing a call from line 2 to line 6, labeled 'Function call'.

Monitoring functions

As well as monitoring program run states, variables, input/output signals and other events, these functions can show graphs of robot operation waveforms (speeds and current values) and I/O states in real time. This makes it easy to see the correlation between program execution steps and waveform data, making debugging markedly more efficient.

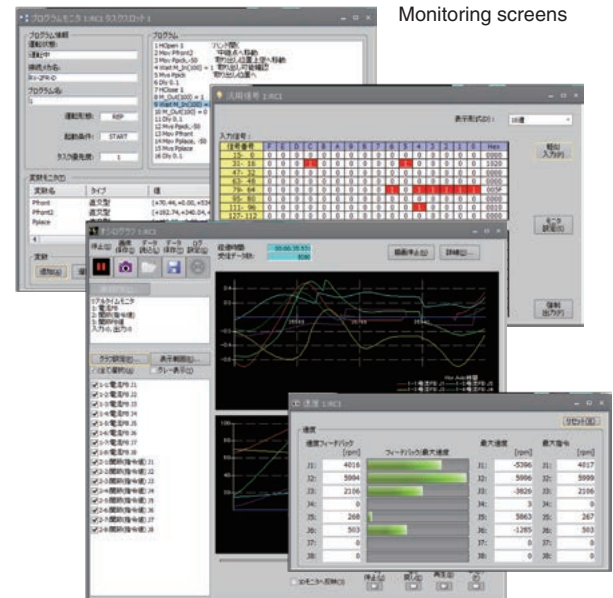

Library function

Keeping a library of program processing allows knowledge to be accumulated and provides improved reusability. The libraries can also be hidden to prevent knowledge from being disclosed.

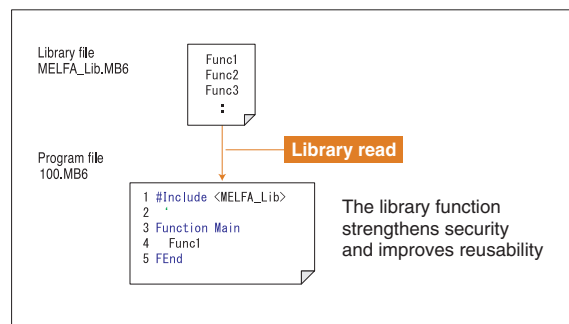

MELFA RV-2FR RV-2FRL

Vertical 2kg type

RV-2FR RV-2FRL

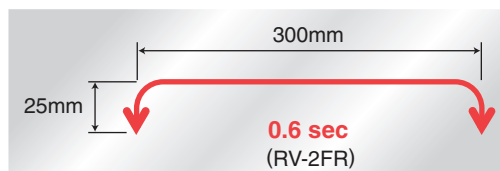

Compact body and slender arms cover large work areas. An ideal robot for compact cell construction. Perfect for transporting, assembling and inspecting small components.

- Among the fastest moving robots in its class
[Max. composite speed: 5.0 m/s] (RV-2FR)
- Standard cycle time
[0.6 second range] (RV-2FR)
- Pivotal operating range: $\pm 240^\circ$
- Environmental specifications [standard: IP30]
- Standards compliance
Compliant with European Machinery Directives (CE) as standard. Compliance with other standards is available in specialized machines. Contact Mitsubishi Electric for details.

Specifications

Type	Unit	RV-2FR (B)	RV-2FRL (B)
Environmental specifications		Standard	
Protection degree		IP30	
Installation		Floor type, ceiling type, (wall-mounted type *2)	
Structure		Vertical multiple-joint type	
Degrees of freedom		6	
Drive system *1		AC servo motor (J2, J3 and J5: with brake)	
Position detection method		Absolute encoder	
Maximum load capacity	kg	Maximum 3 (Rated 2) *5	
Arm length	mm	230+270	310+335
Maximum reach radius	mm	504	649
Operating range	J1	480 (± 240)	
	J2	240 (-120 to +120)	237 (-117 to +120)
	J3	160 (-0 to +160)	
	J4	400 (± 200)	
	J5	240 (-120 to +120)	
	J6	720 (± 360)	
Maximum speed	J1	300	225
	J2	150	105
	J3	300	165
	J4	450	412
	J5	450	
	J6	720	
Maximum composite speed *3	mm/sec	4955	4200
Cycle time *4	sec	0.6	0.7
Position repeatability	mm	± 0.02	
Ambient temperature	$^\circ\text{C}$	0 to 40	
Mass	kg	19	21
Tolerable moment	J4	4.17	
	J5	4.17	
	J6	2.45	
Tolerable amount of inertia	J4	0.18	
	J5	0.18	
	J6	0.04	
Tool wiring		Gripper: 4 input points/4 output points Signal cable for the multi-function gripper	
Tool pneumatic pipes		$\phi 4 \times 4$	
Machine cable		5m (connector on both ends)	
Connected controller *6		CR800-D, CR800-R, CR800-Q	

► External Dimensions/Operating Range Diagram

RV-2FR

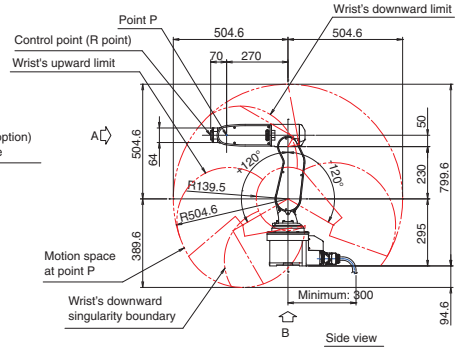
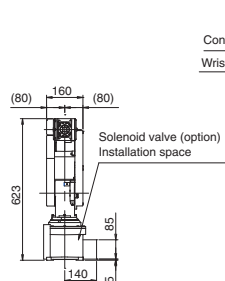
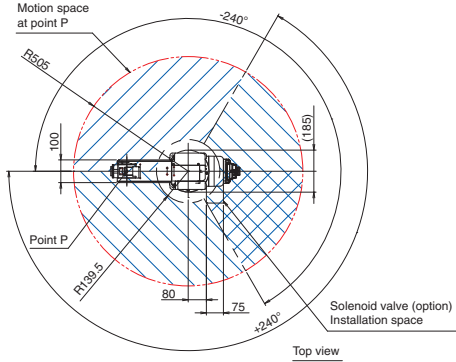

RV-2FRL

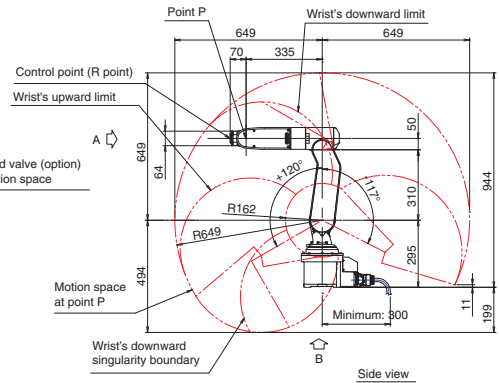
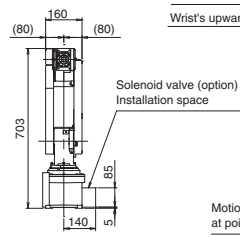
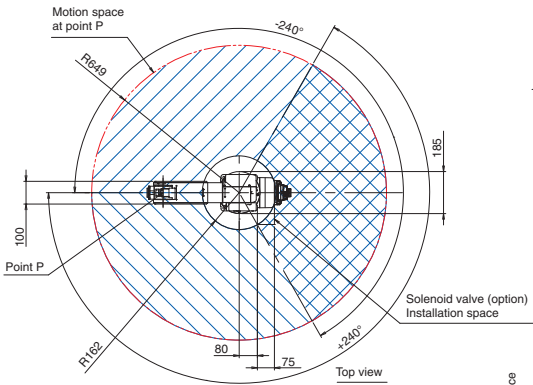

Shared parts

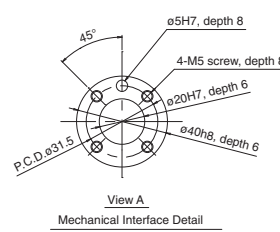
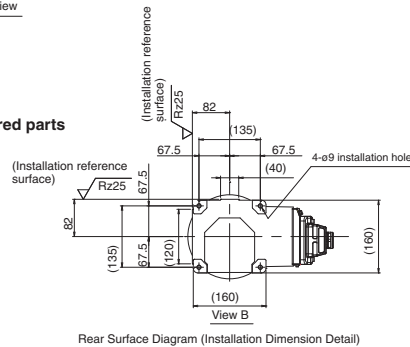

*Operating range limit
 When the J1-axis angle is inside the range of -75°<J1<70° and the J2-axis angle is J2<-110°, operating range of the J3-axis is limited to 80°≤J3.

RV-2FR

RV-2FR - D

Robot structure

RV: Vertical, multiple-joint type

Maximum load capacity

2: 2kg

Series

FR: FR series

Controller type

D: CR800-D

R: CR800-R

Q: CR800-Q

Brake specification

Blank: No brake for J1, J4 and J6 axis

B: All axis with brake

RV-2FRL

RV-2FRL - D

Robot structure

RV: Vertical, multiple-joint type

Maximum load capacity

2: 2kg

Series

FR: FR series

Controller type

D: CR800-D

R: CR800-R

Q: CR800-Q

Brake specification

Blank: No brake for J1, J4 and J6 axis

B: All axis with brake

Arm length

Blank: Standard arm

L: Long arm

*1: The standard model does not have a brake on the J1, J4, or J6 axis. There are models available with brakes included for all axes.
 *2: The wall-mounted specification is a custom specification where the operating range of the J1-axis is limited.
 *3: This is the value at the surface of the mechanical interface when all axes are composited.
 *4: The cycle time is based on back-and-forth movement over a vertical distance of 25 mm and horizontal distance of 300 mm when the load is 1 kg.
 *5: The maximum load capacity indicates the maximum payload when the mechanical interface is facing downward (±10° to the perpendicular).
 *6: Select a controller according to the application. CR800-D: Standalone type, CR800-R: MELSEC iQ-R compatible type, CR800-Q: MELSEC Q compatible type.

MELFA RV-4FR RV-4FRL

Vertical 4kg type

RV-4FR RV-4FRL



Cutting-edge servo control and optimized arm construction provide extremely fast and precise heavy-duty operation. Flap-style arms provide a range of movement ideally suited to compact areas. The use of space is highly efficient. Perfect for transporting, assembling and inspecting small components.

- Among the fastest moving robots in its class
[Max. composite speed: 9.0 m/s]
- Standard cycle time
[0.36 s]
- Pivotal operating range: $\pm 240^\circ$
- Environmental specifications
[standard: IP40; oil mist: IP67; cleanroom: ISO class 3]
- Standards compliance
Compliant with European Machinery Directives (CE) as standard.
Compliance with other standards is available in specialized machines.
Contact Mitsubishi Electric for details.

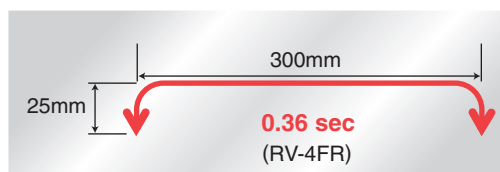

► Specifications

Type	Unit	RV-4FR (M) (C)	RV-4FRL (M) (C)
Environmental specifications		Standard/ Oil mist/ Cleanroom	
Protection degree		IP40 (standard)/ IP67 (oil mist) *1/ ISO class3 *7	
Installation		Floor type, ceiling type, (wall-mounted type *2)	
Structure		Vertical multiple-joint type	
Degrees of freedom		6 *9	
Drive system		AC servo motor	
Position detection method		Absolute encoder	
Maximum load capacity	kg	Maximum 4 (Rated 4) *8	
Arm length	mm	235+275	310+335
Maximum reach radius	mm	515	649
Operating range	J1	480 (± 240)	
	J2	240 (-120 to +120)	
	J3	161 (-0 to +161)	164 (-0 to +164)
	J4	400 (± 200)	
	J5	240 (-120 to +120)	
	J6	720 (± 360)	
Maximum speed	J1	450	420
	J2	450	336
	J3	300	250
	J4	540	540
	J5	623	623
	J6	720	720
Maximum composite speed *3	mm/sec	9027	9048
Cycle time *4	sec	0.36	0.36
Position repeatability	mm	± 0.02	
Ambient temperature	$^\circ\text{C}$	0 to 40	
Mass	kg	39	41
Tolerable moment	J4	6.66	
	J5	6.66	
	J6	3.96	
Tolerable amount of inertia	J4	0.2	
	J5	0.2	
	J6	0.1	
Tool wiring		Gripper: 8 input points/8 output points Signal cable for the multi-function gripper and sensors LAN x 1 <100 BASE-TX> *5	
Tool pneumatic pipes		Primary: $\phi 6 \times 2$ Secondary: $\phi 4 \times 8, \phi 4 \times 4$ (from base portion to forearm)	
Machine cable		5m (connector on both ends)	
Connected controller *6		CR800-D, CR800-R, CR800-Q	

▶ External Dimensions/Operating Range Diagram

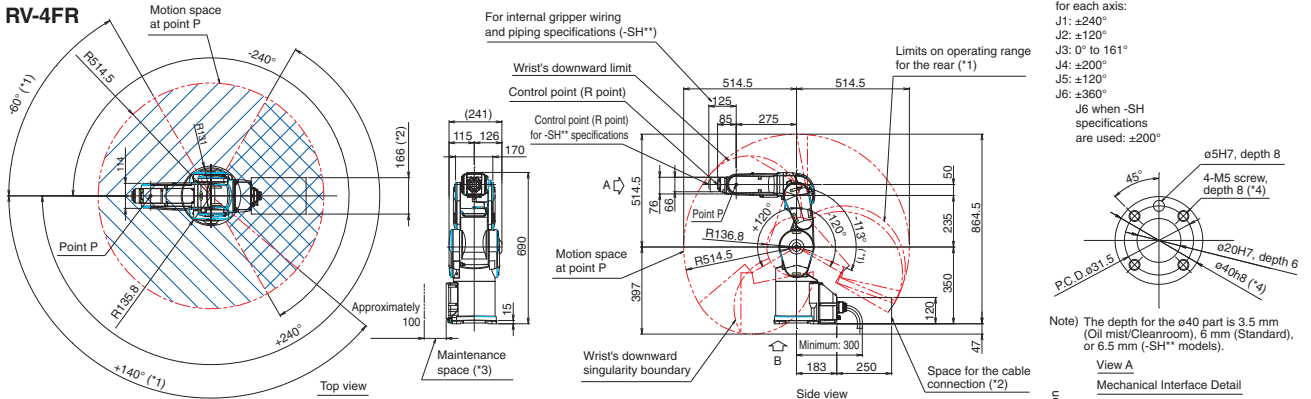

Notes
 *1: Limits on the operating range for the back and side parts: When the J1-axis angle is inside the range of $-60^{\circ} \leq J1 \leq +140^{\circ}$, the operating range of the J2-axis is limited to $-113^{\circ} \leq J2 \leq +120^{\circ}$.
 *2: Make sure to leave enough space open for cable connections between devices.
 *3: Make sure to leave enough space open for removing and attaching covers during maintenance work.
 *4: Specify a thread engagement length of 7.5 to 8 mm.

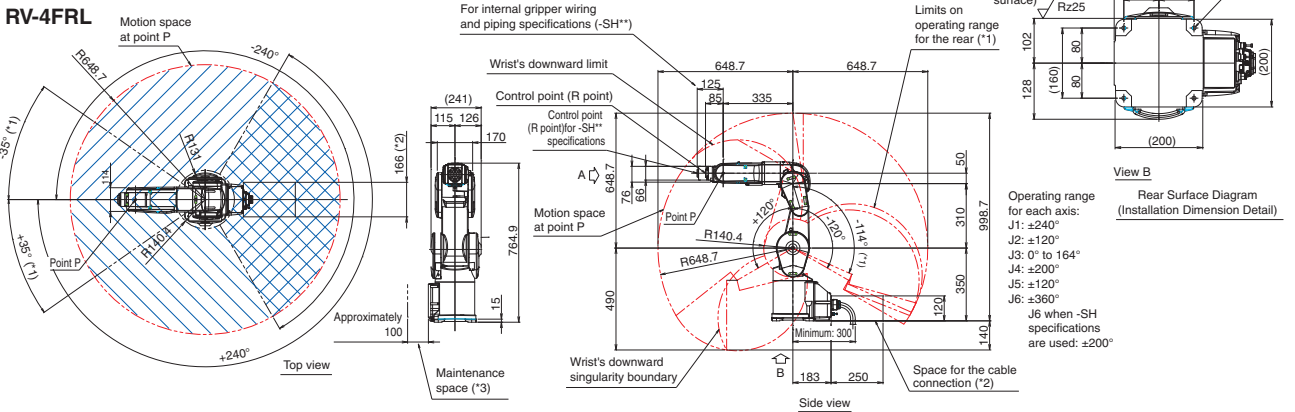

Notes
 *1: Limits on the operating range for the back and side parts: When the J1-axis angle is inside the range of $-35^{\circ} \leq J1 \leq +35^{\circ}$, the operating range of the J2-axis is limited to $-114^{\circ} \leq J2 \leq +120^{\circ}$.
 *2: Make sure to leave enough space open for cable connections between devices.
 *3: Make sure to leave enough space open for removing and attaching covers during maintenance work.
 *4: Specify a thread engagement length of 7.5 to 8 mm.

▶ Mounting cable specifications (*1)

Devices that can be mounted	Model (machine no.)				
	-SH01	-SH02	-SH03	-SH04	-SH05
Air ø4	○ (x4)	-	-	○ (x2)	○ (x2)
Gripper input 8 points	○	○	○	○	○
Vision sensor	-	○	○	○	○
Force sensor	-	○	○	○	-
Electric gripper	-	○	○	-	-

*1) The J6 axis range of motion is ±200deg. Protection level is IP40.

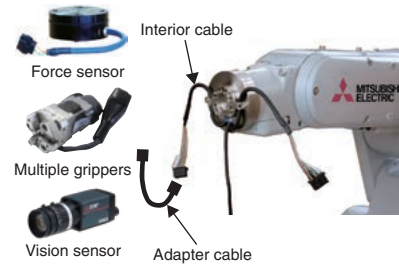

RV-4FRL - D -

Robot structure
 RV: Vertical, multiple-joint type

Maximum load capacity
 4: 4kg

Series
 FR: FR series

Arm length
 Blank: Standard arm
 L: Long arm

Special device No.
 SHxx: Internal wiring specifications

Controller type
 D: CR800-D
 R: CR800-R
 Q: CR800-Q

Environment specification
 Blank: Standard specifications
 M: Oil mist specifications
 C: Cleanroom specifications

*1: Please contact Mitsubishi Electric dealer since the environmental resistance may not be secured depending on the characteristics of oil you use. Air will need to be purged from the lines. For details, refer to the specifications sheet.
 *2: The wall-mounted specification is a custom specification where the operating range of the J1-axis is limited.
 *3: This is the value at the surface of the mechanical interface when all axes are composited.
 *4: Value for a 25mm up/down and 300mm horizontal reciprocal movement with 1kg load. The cycle time is the value for RV-4FR-R and RV-4FRL-R.
 *5: This can also be used as a spare wire (0.13sq 4-pair wire.) The wire is prepared up to inside the forearm.
 *6: Select one of the following controllers according to the application. CR800-D: Standalone type, CR800-R: MELSEC iQ-R compatible type, CR800-Q: MELSEC Q Series compatible type.
 *7: Preservation of cleanliness levels depends on conditions of a downstream flow of 0.3 m/s in the cleanroom and internal robot suctioning. A ø8-mm coupler for suctioning is provided at the back of the base.
 *8: The maximum load capacity indicates the maximum payload when the mechanical interface is facing downward (±10° to the perpendicular).
 *9: Please contact our sales offices if you request a five axes long arm model.

MELFA
RV-7FR
RV-7FRL
RV-7FRLL

Vertical
7kg
type

RV-7FR
RV-7FRL
RV-7FRLL



Cutting-edge servo control and optimized arm construction provide extremely fast and precise heavy-duty operation. Increased range of movement along each axis and slender arms to cover large work areas. An ideal robot for compact cell construction. The product line includes a model with a maximum reach radius of 1503 mm for a larger operating range.

- Among the fastest moving robots in its class
 [Max. composite speed: 11.0 m/s (RV-7FR)]
- Standard cycle time [0.32 s (RV-7FR)]
- Pivotal operating range: $\pm 240^\circ$ (RV-7FR/7FRL)
- Environmental specifications
 [standard: IP40; oil mist: IP67; cleanroom: ISO class 3]
- Standards compliance
 Compliant with European Machinery Directives (CE) as standard.
 Compliance with other standards is available in specialized machines.
 Contact Mitsubishi Electric for details.

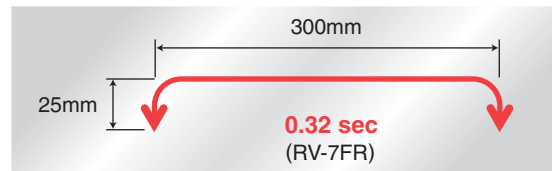

► **Specifications**

Type	Unit	RV-7FR (M) (C)	RV-7FRL (M) (C)	RV-7FRLL (M) (C)
Environmental specifications		Standard/ Oil mist/ Cleanroom		
Protection degree		IP40 (standard)/ IP67 (oil mist) *1/ ISO class3 *7		
Installation		Floor type, ceiling type, (wall-mounted type *2)		
Structure		Vertical multiple-joint type		
Degrees of freedom		6		
Drive system		AC servo motor		
Position detection method		Absolute encoder		
Maximum load capacity	kg	Maximum 7 (Rated 7) *8		
Arm length	mm	340+370	435+470	565+805
Maximum reach radius	mm	713	908	1503
Operating range	J1	480 (± 240)		380 (± 190)
	J2	240 (-115 to +125)	240 (-110 to +130)	240 (-90 to +150)
	J3	156 (-0 to +156)	162 (-0 to +162)	167.5 (-10 to +157.5)
	J4	400 (± 200)		
	J5	240 (-120 to +120)		
	J6	720 (± 360)		
Maximum speed	J1	360	288	234
	J2	401	321	164
	J3	450	360	219
	J4	337		
	J5	450		
	J6	720		
Maximum composite speed *3	mm/sec	11064	10977	15300
Cycle time *4	sec	0.32	0.35	0.63
Position repeatability	mm			± 0.02
Ambient temperature	$^\circ\text{C}$			0 to 40
Mass	kg	65	67	130
Tolerable moment	J4	16.2		
	J5	16.2		
	J6	6.86		
Tolerable amount of inertia	J4	0.45		
	J5	0.45		
	J6	0.10		
Tool wiring		Gripper: 8 input points, Signal cable for the multi-function gripper, LAN \times 1 <100 BASE-TX> *5		
Tool pneumatic pipes		Primary: $\phi 6 \times 2$ Secondary: $\phi 4 \times 8$, $\phi 4 \times 4$ (from base portion to forearm)		
Machine cable		5m (connector on both ends)		
Connected controller *6		CR800-D, CR800-R, CR800-Q		

*1: Please contact Mitsubishi Electric dealer since the environmental resistance may not be secured depending on the characteristics of oil you use.
 *2: The wall-mounted specification is a custom specification where the operating range of the J1-axis is limited.
 *3: This is the value at the surface of the mechanical interface when all axes are composited.
 *4: Value for a 25mm up/down and 300mm horizontal reciprocal movement with 1kg. The cycle time is the value for RV-7FR-R, RV-7FRL-R, RV-7FRLL-R.
 *5: Can also be used as a spare line (0.13 sq. mm, 4-pair cable) for conventional models.
 *6: Select either controller according to your application. CR800-D: Standalone type, CR800-R: MELSEC iQ-R compatible type, CR800-Q: MELSEC Q Series compatible type.
 *7: Preservation of cleanliness levels depends on conditions of a downstream flow of 0.3 m/s in the cleanroom and internal robot suctioning. A $\phi 8$ -mm coupler for suctioning is provided at the back of the base.
 *8: The maximum load capacity indicates the maximum payload when the mechanical interface is facing downward ($\pm 10^\circ$ to the perpendicular).

▶ External Dimensions/Operating Range Diagram

RV-7FR

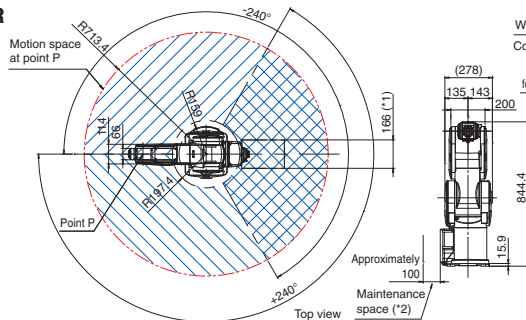

Notes
 *1. Make sure to leave enough space open for cable connections between devices.
 *2. Make sure to leave enough space open for removing and attaching covers during maintenance work.
 *3. Specify a thread engagement length of 7.5 to 8 mm.

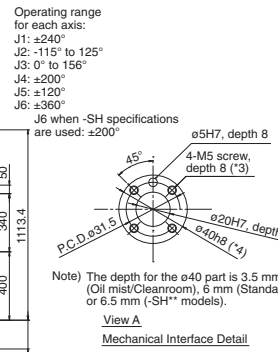
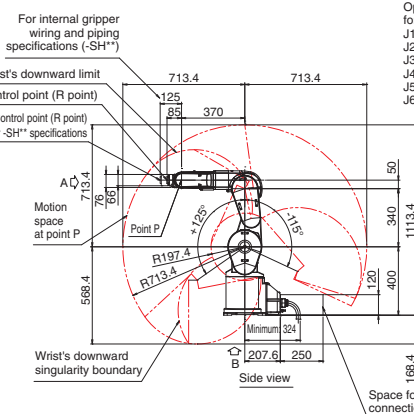

RV-7FRL

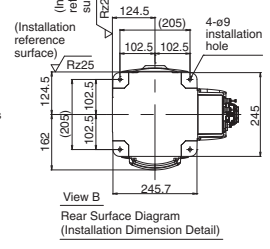
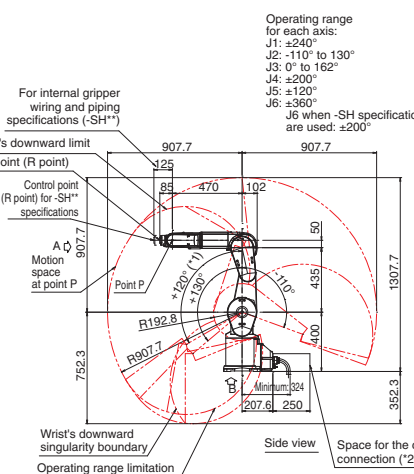
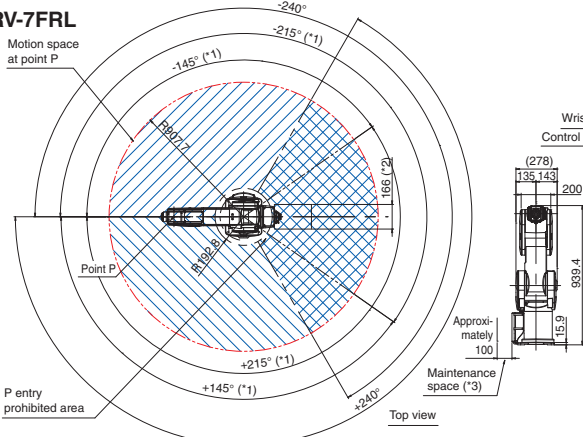

Dedicated for RV-7FRL

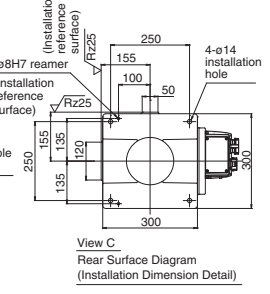

RV-7FRL

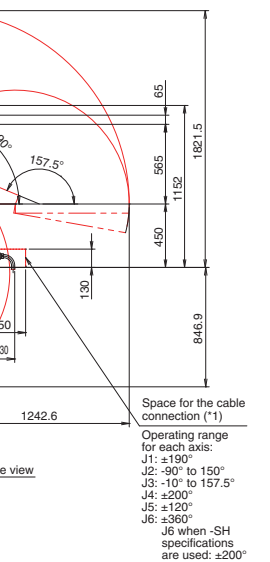
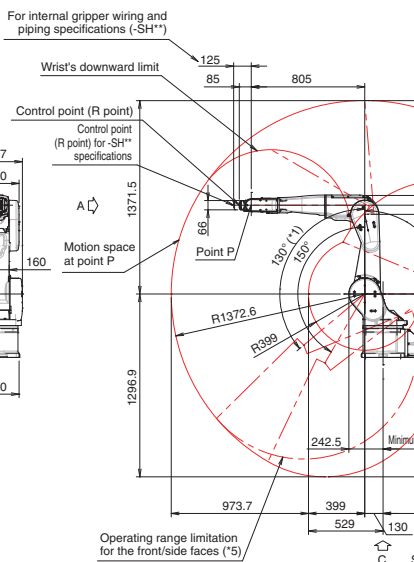
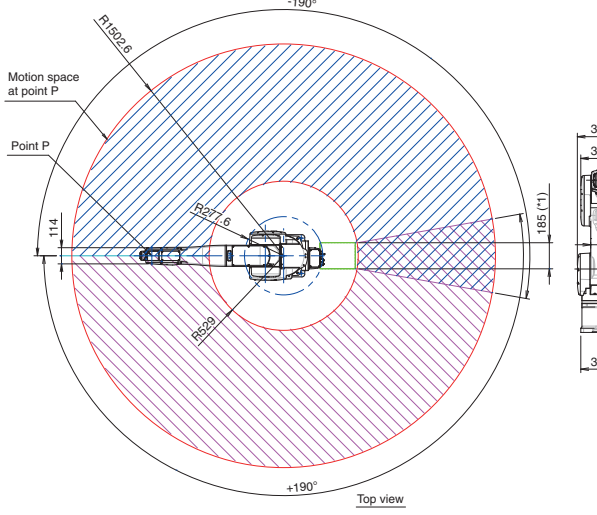

*1. Make sure to leave enough space open for cable connections between devices.
 *2. Make sure to leave enough space open for removing and attaching covers during maintenance work.
 *3. Specify a thread engagement length of 7.5 to 8 mm.
 *4. Limits on the operating range for the front part: When the J1-axis angle is inside the range of +145° ≤ J1 ≤ +215° or -145° ≤ J1 ≤ -215°, the operating range of the J2-axis is limited to -110° ≤ J2 ≤ +120°.
 *5. Limits on the operating range for the front part: When the J1-axis angle is inside the range of J1 ≥ +120° or J1 ≤ -120°, the operating range of the J2-axis is limited to -90° ≤ J2 ≤ +130°.
 *6. Refer to the standard specification manual for detailed specification of -SH.

▶ Mounting cable specifications (*1)

Devices that can be mounted	Model (machine no.)				
	-SH01	-SH02	-SH03	-SH04	-SH05
Air ø4	○ (x4)	-	-	○ (x2)	○ (x2)
Gripper input 8 points	○	○	-	○	○
Vision sensor	-	○	○	-	-
Force sensor	-	○	○	○	-
Electric gripper	-	(may be used for either device)	○	-	-

*1) The J6 axis range of motion is ±200deg. Protection level is IP40.

RV-7FRL -D-

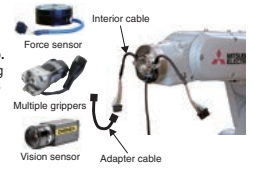
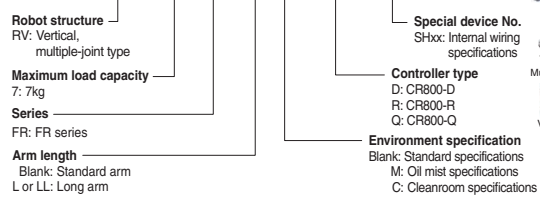

MELFA RV-13FR RV-13FRL

Vertical 13kg type

RV-13FR RV-13FRL



Cutting-edge servo control and optimized arm construction provide extremely fast and precise heavy-duty operation. Optimized arm length and 6 joints for a broader range of movement support a wide range of layouts. Designed to withstand environmental conditions, it can be used in a wide range of applications without having to worry about the installation environment. Suitable for various types of work, such as transporting mechanical parts, assembling electrical components and even packaging products such as pharmaceuticals and foodstuffs.

- Among the fastest moving robots in its class
[Max. composite speed: 10.5 m/s (RV-13FR)]
- Standard cycle time [0.53 s (RV-13FR)]
- Pivotal operating range: $\pm 190^\circ$
- Environmental specifications
[standard: IP40; oil mist: IP67; cleanroom: ISO class 3]
- Standards compliance
Compliant with European Machinery Directives (CE) as standard.
Compliance with other standards is available in specialized machines.
Contact Mitsubishi Electric for details.

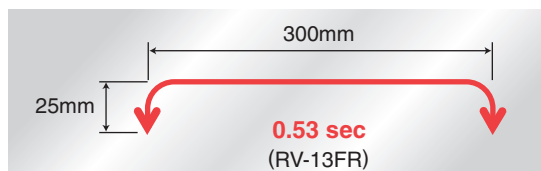

Specifications

Type	Unit	RV-13FR (M) (C)	RV-13FRL (M) (C)
Environmental specifications		Standard/ Oil mist/ Cleanroom	
Protection degree		IP40 (standard)/ IP67 (oil mist) *1/ ISO class3 *7	
Installation		Floor type, ceiling type, (wall-mounted type *2)	
Structure		Vertical, multiple-joint type	
Degrees of freedom		6	
Drive system		AC servo motor	
Position detection method		Absolute encoder	
Maximum load capacity	kg	Maximum 13 (Rated 12) *8	
Arm length	mm	410+550	565+690
Maximum reach radius	mm	1094	1388
Operating range	J1	380 (± 190)	
	J2	240 (-90 to +150)	
	J3	167.5 (-10 to +157.5)	
	J4	400 (± 200)	
	J5	240 (-120 to +120)	
	J6	720 (± 360)	
Maximum speed	J1	290	234
	J2	234	164
	J3	312	219
	J4	375	375
	J5	375	375
	J6	720	720
Maximum composite speed *3	mm/sec	10450	9700
Cycle time *4	sec	0.53	0.68
Position repeatability	mm	± 0.05	
Ambient temperature	$^\circ\text{C}$	0 to 40	
Mass	kg	120	130
Tolerable moment	J4	19.3	
	J5	19.3	
	J6	11	
Tolerable amount of inertia	J4	0.47	
	J5	0.47	
	J6	0.14	
Tool wiring		Gripper: 8 input points/8 output points Signal cable for the multi-function gripper LAN \times 1 <100 BASE-TX> *5	
Tool pneumatic pipes		Primary: $\phi 6 \times 2$ Secondary: $\phi 6 \times 8, \phi 4 \times 4$ (from base portion to forearm)	
Machine cable		5m (connector on both ends)	
Connected controller *6		CR800-D, CR800-R, CR800-Q	

MELFA RV-20FR

Vertical 20kg type

RV-20FR



Highly portable RV-F series (maximum load capacity: 20 kg). Cutting-edge servo control and optimized arm construction provide extremely portable and precise heavy-duty operation. Optimized arm length and 6 joints for a broader range of movement support a wide range of layouts. Designed to withstand environmental conditions, it can be used in a wide range of applications without having to worry about the installation environment. Plenty of scope for using multiple grippers or multi-function grippers and capable of handling work such as transporting high-load mechanical parts, assembling electrical components and packaging pharmaceutical products.

- Standard cycle time [0.7 s]
- Pivotal operating range: $\pm 190^\circ$
- Environmental specifications
[standard: IP40; oil mist: IP67; cleanroom: ISO class 3]
- Standards compliance
Compliant with European Machinery Directives (CE) as standard.
Compliance with other standards is available in specialized machines.
Contact Mitsubishi Electric for details.

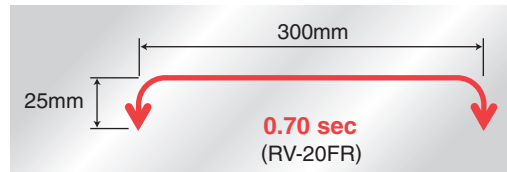

► Specifications

Type	Unit	RV-20FR (M) (C)
Environmental specifications		Standard/ Oil mist/ Cleanroom
Protection degree		IP40 (standard)/ IP67 (oil mist) *1/ ISO class3 *7
Installation		Floor type, ceiling type, (wall-mounted type *2)
Structure		Vertical multiple-joint type
Degrees of freedom		6
Drive system		AC servo motor
Position detection method		Absolute encoder
Maximum load capacity	kg	Maximum 20 (Rated 15) *8
Arm length	mm	410+550
Maximum reach radius	mm	1094
Operating range	J1	380 (± 190)
	J2	240 (-90 to +150)
	J3	167.5 (-10 to +157.5)
	J4	400 (± 200)
	J5	240 (-120 to +120)
	J6	720 (± 360)
Maximum speed	J1	110
	J2	110
	J3	110
	J4	124
	J5	125
	J6	360
Maximum composite speed *3	mm/sec	4200
Cycle time *4	sec	0.70
Position repeatability	mm	± 0.05
Ambient temperature	$^\circ\text{C}$	0 to 40
Mass	kg	120
Tolerable moment	J4	49.0
	J5	49.0
	J6	11
Tolerable amount of inertia	J4	1.40
	J5	1.40
	J6	0.14
Tool wiring		Gripper: 8 input points/8 output points Signal cable for the multi-function gripper LAN x 1 <100 BASE-TX> *5
Tool pneumatic pipes		Primary: $\phi 6 \times 2$ Secondary: $\phi 6 \times 8, \phi 4 \times 4$ (from base portion to forearm)
Machine cable		5m (connector on both ends)
Connected controller *6		CR800-D, CR800-R, CR800-Q

▶ External Dimensions/Operating Range Diagram

RV-13FR

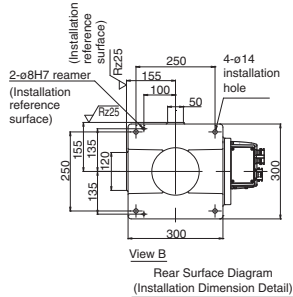
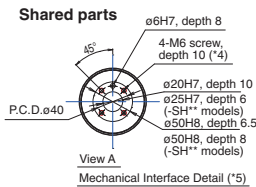
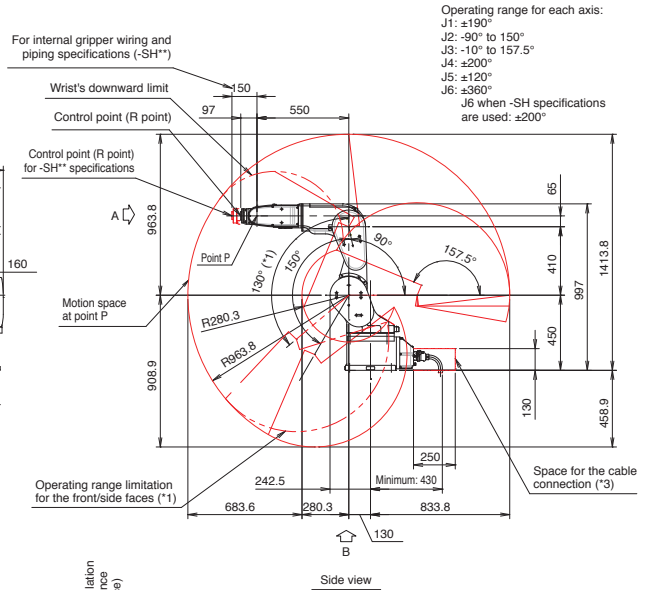
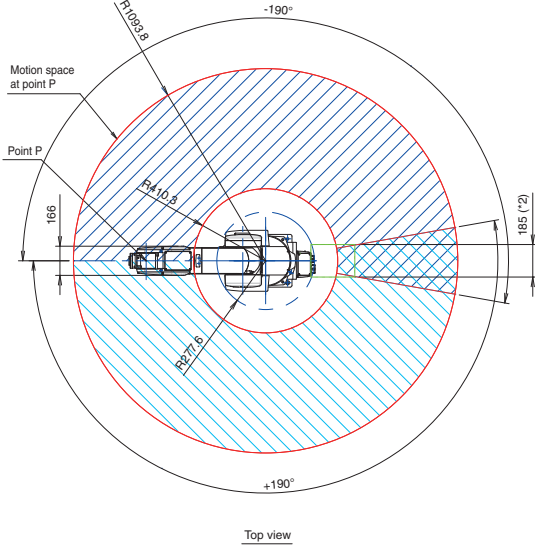

*1: Operating range for the front and side parts: When the J1-axis angle is inside the range of J1₂+120° or J1₂-130°, the operating range of the J2-axis is limited to -90° ≤ J2 ≤ +130°.
 *2: Make sure to leave enough space open for cable connections between devices.
 *3: Specify a thread engagement length of 10 to 9mm.
 *4: Refer to the standard specification manual for detailed specification of -SH.

▶ Mounting cable specifications (*1)

Devices that can be mounted	Model (machine no.)				
	-SH01	-SH02	-SH03	-SH04	-SH05
Air ø4	○ (x4)	-	-	○ (x2)	○ (x2)
Gripper input 8 points	○	○	○	○	○
Vision sensor	-	○	○	○	○
Force sensor	-	○	○	○	-
Electric gripper	-	(may be used for either device)	○	-	-

*1) The J6 axis range of motion is ±200deg. Protection level is IP40.

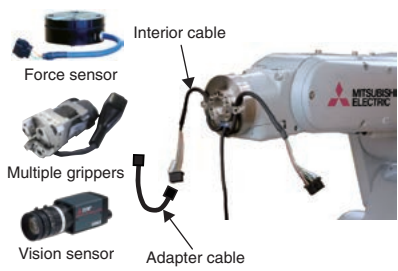

RV-20FR **-D-**

Robot structure
RV: Vertical, multiple-joint type

Maximum load capacity
20: 20kg

Series
F: FR series

Special device No.
SHxx: Internal wiring specifications

Controller type
D: CR800-D
R: CR800-R
Q: CR800-Q

Environment specification
Blank: Standard specifications
M: Oil mist specifications
C: Cleanroom specifications

*1: Please contact Mitsubishi Electric dealer since the environmental resistance may not be secured depending on the characteristics of oil you use.
 *2: The wall-mounted specification is a custom specification where the operating range of the J1-axis is limited.
 *3: This is the value at the surface of the mechanical interface when all axes are composited.
 *4: Value for a 25mm up/down and 300mm horizontal reciprocal movement with 5kg load. The cycle time is the value for RV-20FR-R.
 *5: Can also be used as a spare line (0.13 sq. mm, 4-pair cable) for conventional models. Provided up to the inside of the forearm.
 *6: Select either controller according to your application. CR800-D: Standalone type, CR800-R: MELSEC iQ-R compatible type, CR800-Q: MELSEC Q Series compatible type.
 *7: Preservation of cleanliness levels depends on conditions of a downstream flow of 0.3 m/s in the cleanroom and internal robot suctioning.
 A ø8-mm coupler for suctioning is provided at the back of the base.
 *8: The maximum load capacity indicates the maximum payload when the mechanical interface is facing downward (±10° to the perpendicular).

MELFA
RH-3FRH35
RH-3FRH45
RH-3FRH55

Horizontal
3kg
type

RH-3FRH35
RH-3FRH45
RH-3FRH55



Ideal for compact cell construction, such as assembling or transporting small workpieces.

- Among the fastest moving robots in its class
 [XY composite: 8,300 mm/s]
 [J4 (θ axis): 3,000 deg/s]
- Standard cycle time
 [0.41 s (RH-3FRH35)]
- Pivotal operating range: $\pm 170^\circ$
- Environmental specifications
 [standard: IP20; cleanroom: ISO class 3]
- Standards compliance
 Compliant with European Machinery Directives (CE) as standard.
 Compliance with other standards is available in specialized machines.
 Contact Mitsubishi Electric for details.

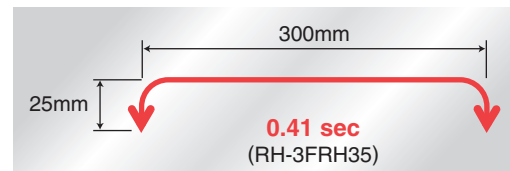

Specifications

Type	Unit	RH-3FRH35/12C	RH-3FRH45/12C	RH-3FRH55/12C	
Environmental specifications			Standard/ Cleanroom		
Protection degree *1			IP20/ ISO class3 *6		
Installation			Floor type		
Structure			Horizontal multiple-joint type		
Degrees of freedom			4		
Drive system			AC servo motor		
Position detection method			Absolute encoder		
Maximum load capacity	kg		Maximum 3 (Rated 1)		
Arm length	NO1 arm	mm	125	225	325
	NO2 arm	mm		225	
Maximum reach radius	mm	350	450	550	
Operating range	J1	deg	340 (± 170)		
	J2	deg	290 (± 145)		
	J3 (Z)	mm	150 (Clean specification: 120) *1		
	J4 (θ)	deg	720 (± 360)		
Maximum speed	J1	deg/sec	420		
	J2	deg/sec	720		
	J3 (Z)	mm/sec	1100		
	J4 (θ)	deg/sec	3000		
Maximum composite speed *2	mm/sec	6800	7500	8300	
Cycle time *3	sec	0.41	0.46	0.51	
Position repeatability	Y-X composite	mm	± 0.010	± 0.010	± 0.012
	J3 (Z)	mm	± 0.01		
	J4 (θ)	deg	± 0.004		
Ambient temperature	$^\circ\text{C}$	0 to 40			
Mass	kg	29	29	32	
Tolerable amount of inertia	Rating	0.005			
	Maximum	0.06			
Tool wiring		Gripper: 8 input points/8 output points (20 pins total) Signal cable for the multi-function gripper (2-pin + 2-pin power line) LAN x 1 <100 BASE-TX> (8-pin) *4			
Tool pneumatic pipes		Primary: $\phi 6 \times 2$ Secondary: $\phi 4 \times 8$			
Machine cable		5m (connector on both ends)			
Connected controller *5		CR800-D, CR800-R, CR800-Q			

► External Dimensions/Operating Range Diagram

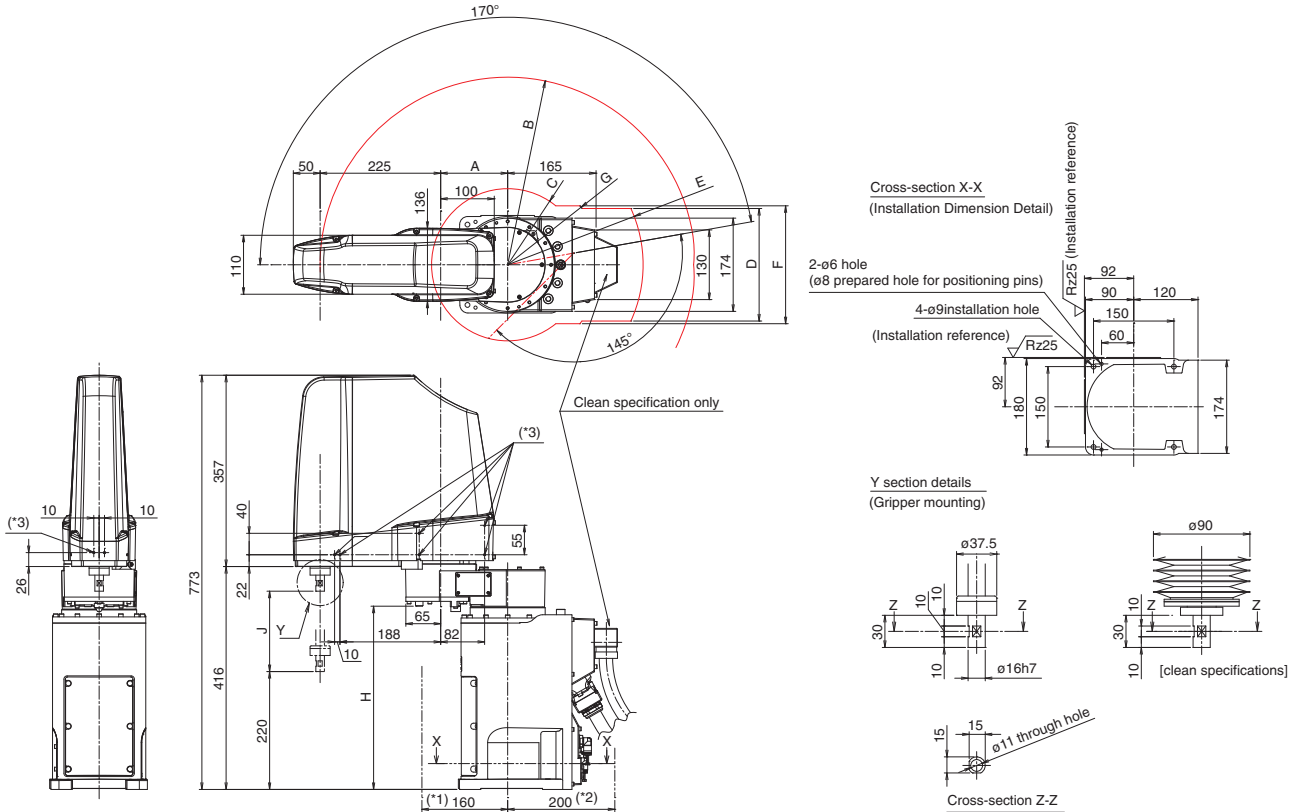

- *1: Space required for the battery replacement
- *2: Space required for the interconnection cable
- *3: Screw holes (M4, 6 mm long) for affixing user wiring and piping. (6 locations on both sides and 2 locations on the front of the No. 2 arm.)

Variable dimensions

Robot series	A	B	C	D	E	F	G	H	J
RH-3FRH3515	125	R350	R142	210	R253	220	R174	342	150
RH-3FRH3512C	125	R350	R142	224	R253	268	R196	342	120
RH-3FRH4515	225	R450	R135	210	R253	220	R174	337	150
RH-3FRH4512C	225	R450	R135	224	R253	268	R197	337	120
RH-3FRH5515	325	R550	R191	160	R244	172	R197	337	150
RH-3FRH5512C	325	R550	R191	160	R253	259	R222	337	120

RH-3FRH5515-D

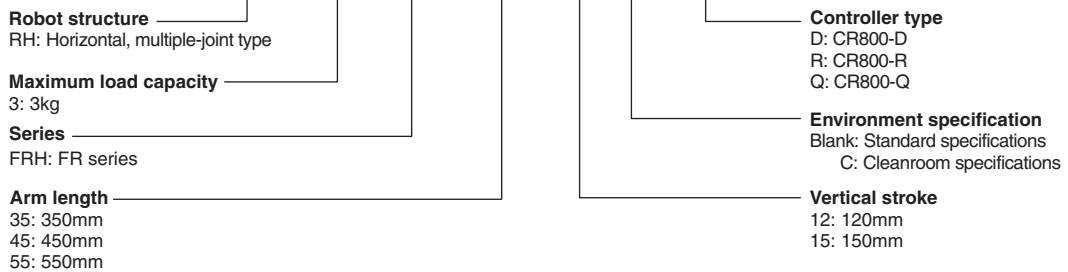

*1: The range for vertical movement listed in the environmental resistance specifications (C: Clean specifications) for the RH-3FRH is narrower than for the standard model. Keep this in mind when working with the RH-3FRH. The environment-resistant specifications are factory-set custom specifications.
 *2: The value assumes composition of J1, J2, and J4.
 *3: Value for a maximum load capacity of 2 kg. The cycle time may increase if specific requirements apply such as high work positioning accuracy, or depending on the operating position. (The cycle time is based on back-and-forth movement over a vertical distance of 25 mm and horizontal distance of 300 mm.)
 *4: Can also be used as a spare line (0.2 sq. mm, 4-pair cable) for conventional models.
 *5: Select either controller according to your application. CR800-D: Standalone type, CR800-R: MELSEC iQ-R compatible type, CR800-Q: MELSEC Q Series compatible type.
 *6: Preservation of cleanliness levels depends on conditions of a downstream flow of 0.3 m/s in the cleanroom and internal robot suctioning. A ø8-mm coupler for suctioning is provided at the back of the base.

MELFA
RH-6FRH35
RH-6FRH45
RH-6FRH55

Horizontal
6kg
type

A horizontal, multiple-joint type robot with highly rigid arms and cutting-edge servo controls to provide extremely fast and precise heavy-duty operation. Ideal for a wide range of fields, from transportation of small components that demands high-speed operation through to assembly work where excellent precision is required.

- Among the fastest moving robots in its class
 [XY composite: 8,300 mm/s]
 [J4 (θ axis): 2,400 deg/s]
- Standard cycle time
 [0.29 s (RH-6FRH55)]
- Pivotal operating range: $\pm 170^\circ$
- Environmental specifications
 [standard: IP20; oil mist: IP65; cleanroom: ISO class 3]
- Standards compliance
 Compliant with European Machinery Directives (CE) as standard.
 Compliance with other standards is available in specialized machines.
 Contact Mitsubishi Electric for details.

RH-6FRH35
RH-6FRH45
RH-6FRH55

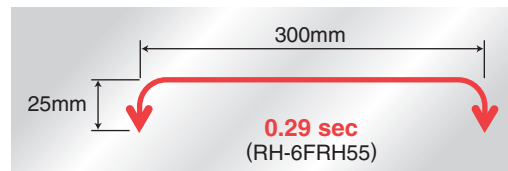

► **Specifications**

Type	Unit	RH-6FRH35XX/M/C	RH-6FRH45XX/M/C	RH-6FRH55XX/M/C
Environmental specifications			Standard/ Oil mist/ Cleanroom	
Protection degree *1			IP20/IP65 *6, ISO class3 *7	
Installation			Floor type	
Structure			Horizontal multiple-joint type	
Degrees of freedom			4	
Drive system			AC servo motor	
Position detection method			Absolute encoder	
Maximum load capacity	kg		Maximum 6 (Rated 3)	
Arm length	NO1 arm	125	225	325
	NO2 arm		225	
Maximum reach radius	mm	350	450	550
Operating range	J1		340 (± 170)	
	J2		290 (± 145)	
	J3 (Z)	mm	xx=20:200, xx=34:340	
	J4 (θ)	deg	720 (± 360)	
Maximum speed	J1	deg/sec	400	
	J2		670	
	J3 (Z)	mm/sec	2400	
	J4 (θ)	deg/sec	2500	
Maximum composite speed *2	mm/sec	6900	7600	8300
Cycle time *3	sec		0.29	
Position repeatability	Y-X composite	mm	± 0.010	
	J3 (Z)		± 0.01	
	J4 (θ)	deg	± 0.004	
Ambient temperature	$^\circ\text{C}$		0 to 40	
Mass	kg	36	36	37
Tolerable amount of inertia	Rating		0.01	
	Maximum		0.12	
Tool wiring			Gripper: 8 input points/8 output points (20 pins total) Signal cable for the multi-function gripper (2-pin + 2-pin power line) LAN x 1 <100 BASE-TX> (8-pin) *4	
Tool pneumatic pipes			Primary: $\phi 6 \times 2$ Secondary: $\phi 4 \times 8$	
Machine cable			5m (connector on both ends)	
Connected controller *5			CR800-D, CR800-R, CR800-Q	

► External Dimensions/Operating Range Diagram

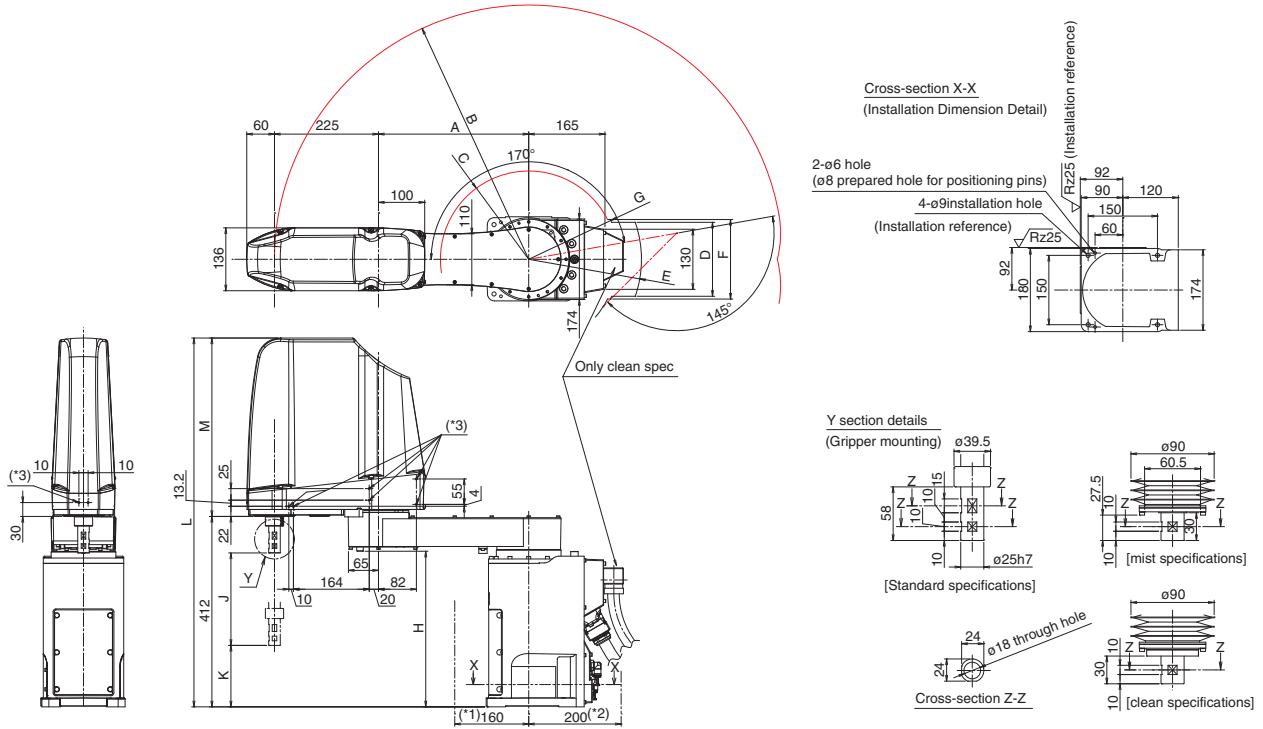

- *1: Space required for the battery replacement
- *2: Space required for the interconnection cable
- *3: Screw holes (M4, 6 mm long) for affixing user wiring and piping. (6 locations on both sides and 2 locations on the front of the No. 2 arm.)

Variable dimensions

Robot series	A	B	C	D	E	F	G	H	J	K	L	M
RH-6FRH3520	125	R350	R142	210	R253	220	R174	342	200	133	798	386
RH-6FRH3520M/C	125	R350	R142	224	R253	268	R196	342	200	133	798	386
RH-6FRH3534	125	R350	R142	210	R253	220	R174	342	340	-7	938	526
RH-6FRH3534M/C	125	R350	R142	224	R253	268	R196	342	340	-43	938	526
RH-6FRH4520	225	R450	R135	210	R253	220	R174	337	200	133	798	386
RH-6FRH4520M/C	225	R450	R135	224	R253	268	R197	337	200	133	798	386
RH-6FRH4534	225	R450	R135	210	R253	220	R174	337	340	-7	938	526
RH-6FRH4534M/C	225	R450	R135	224	R253	268	R197	337	340	-43	938	526
RH-6FRH5520	325	R550	R191	160	R244	172	R197	337	200	133	798	386
RH-6FRH5520C	325	R550	R191	160	R253	259	R222	337	200	133	798	386
RH-6FRH5520M	325	R550	R191	160	R244	259	R222	337	200	133	798	386
RH-6FRH5534	325	R550	R191	160	R244	172	R197	337	340	-7	938	526
RH-6FRH5534C	325	R550	R191	160	R253	259	R222	337	340	-43	938	526
RH-6FRH5534M	325	R550	R191	160	R244	259	R222	337	340	-43	938	526

RH-6FRH5520-D

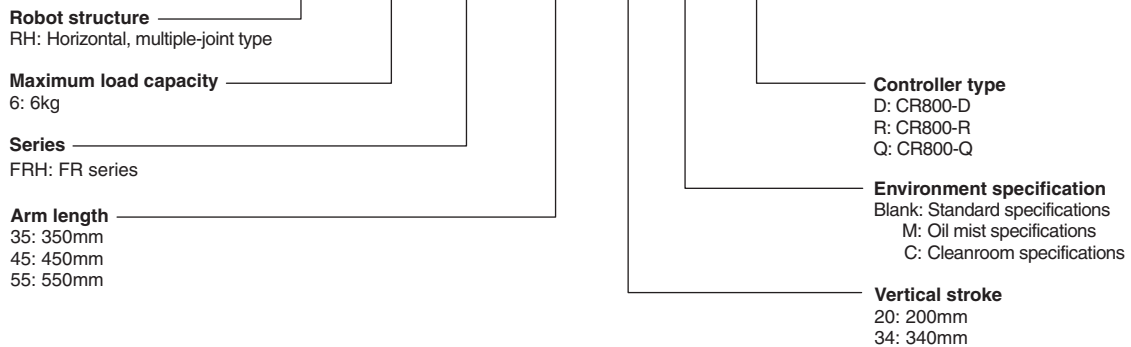

*1: The environmental resistance specifications (M: Oil mist specifications, C: Cleanroom specifications) for the RH-6FRH is factory-set custom specifications.
 *2: The value assumes composition of J1, J2, and J4.
 *3: Value for a maximum load capacity of 2 kg. The cycle time may increase if specific requirements apply such as high work positioning accuracy, or depending on the operating position. (The cycle time is based on back-and-forth movement over a vertical distance of 25 mm and horizontal distance of 300 mm.)
 *4: Can also be used as a spare line (0.2 sq. mm, 4-pair cable) for conventional models.
 *5: Select either controller according to your application. CR800-D: Standalone type, CR800-R: MELSEC iQ-R compatible type, CR800-Q: MELSEC Q Series compatible type.
 *6: Please contact Mitsubishi Electric dealer since the environmental resistance may not be secured depending on the characteristics of oil you use. Direct jet to the bellows is excluded.
 *7: Preservation of cleanliness levels depends on conditions of a downstream flow of 0.3 m/s in the cleanroom and internal robot suctioning. A ø8-mm coupler for suctioning is provided at the back of the base.

MELFA
RH-12FRH55
RH-12FRH70
RH-12FRH85
RH-20FRH85
RH-20FRH100

Horizontal
12/20kg
type

RH-12FRH55
RH-12FRH70
RH-12FRH85
RH-20FRH85
RH-20FRH100

A horizontal, multiple-joint type robot with highly rigid arms and cutting-edge servo controls to provide extremely fast and precise heavy-duty operation. Enhancements to the wrist axis also mean that the robot has ample scope for handling multi-function grippers and offset grippers. Ideal for assembly and palletizing work.

- Among the fastest moving robots in its class
 [XY composite: 13,283 mm/s (RH-20FRH)]
 [J4 (θ axis): 2,400 deg/s (RH-12FRH)]
- Standard cycle time
 [0.30 s (RH-12FRH85)]
- Pivotal operating range: $\pm 170^\circ$
- Environmental specifications
 [standard, Oil mist: IP65; cleanroom: ISO class 3]
- Standards compliance
 Compliant with European Machinery Directives (CE) as standard.
 Compliance with other standards is available in specialized machines.
 Contact Mitsubishi Electric for details.

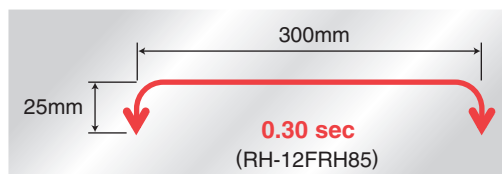

► Specifications

Type		Unit	RH-12FRH55XX/M/C	RH-12FRH70XX/M/C	RH-12FRH85XX/M/C	RH-20FRH85XX/M/C	RH-20FRH100XX/M/C
Environmental specifications			Standard/ Oil mist/ Cleanroom			Standard/ Oil mist/ Cleanroom	
Protection degree *1			IP20/ IP65 *6/ ISO class 3 *7			IP20/ IP65 *6/ ISO class 3 *7	
Installation			Floor type			Floor type	
Structure			Horizontal multiple-joint type				
Degrees of freedom			4				
Drive system			AC servo motor				
Position detection method			Absolute encoder				
Maximum load capacity		kg	Maximum 12 (Rated 3)			Maximum 20 (Rated 5)	
Arm length	NO1 arm	mm	225	375	525	525	525
	NO2 arm			325		325	475
Maximum reach radius		mm	550	700	850	850	1000
Operating range	J1	deg	340 (± 170)			340 (± 170)	
	J2		290 (± 145)			306 (± 153)	
	J3 (Z)	mm	xx=35:350, xx=45:450			xx=35:350, xx=45:450	
	J4 (θ)	deg	720 (± 360)			720 (± 360)	
Maximum speed	J1	deg/sec	420			280	
	J2		450			450	
	J3 (Z)	mm/sec	2800			2400	
	J4 (θ)	deg/sec	2400			1700	
Maximum composite speed *2		mm/sec	11435	12535	11350	11372	13283
Cycle time *3		sec	0.30	0.30	0.30	0.30	0.36
Position repeatability	Y-X composite	mm	± 0.012			± 0.015	
	J3 (Z)		± 0.015			± 0.01	
	J4 (θ)		± 0.005			± 0.005	
Ambient temperature		$^\circ\text{C}$	0 to 40				
Mass		kg	65	67	69	75	77
Tolerable amount of inertia	Rating	kgm ²	0.025			0.065	
	Maximum		0.3			1.05	
Tool wiring			Gripper: 8 input points/8 output points (20 pins total) Signal cable for the multi-function gripper (2-pin + 2-pin power line) LAN x 1 <100 BASE-TX> (8-pin) *4				
Tool pneumatic pipes			Primary: $\phi 6 \times 2$ Secondary: $\phi 6 \times 8$				
Machine cable			5m (connector on both ends)				
Connected controller *5			CR800-D, CR800-R, CR800-Q				

MELFA RH-3FRHR35

Ceiling
mounted,
horizontal
3kg
type

RH-3FRHR35



A horizontal, multiple-joint type robot with a space-saving suspended installation mode. Suitable for a wide range of applications, from precision assembly of electrical, electronic and other small components through to inspections, high-speed transportation and packaging.

- Among the fastest moving robots in its class
[XY composite: 6,267 mm/s]
[J4 (θ axis): 3,146 deg/s]
- Standard cycle time
[0.32 s (RH-3FRHR35)]
- Pivotal operating range: $\pm 225^\circ$
- Environmental specifications
[standard: IP20; cleanroom: ISO class 5; Waterproof: IP65]
- Standards compliance
Compliant with European Machinery Directives (CE) as standard.
Compliance with other standards is available in specialized machines.
Contact Mitsubishi Electric for details.

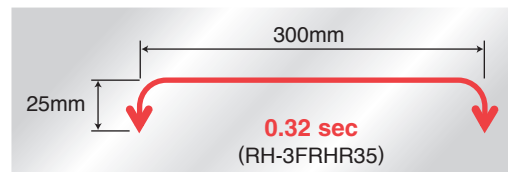

Specifications

Type		Unit	RH-3FRHR3515	RH-3FRHR3512C	RH-3FRHR3512W
Environmental specifications			Standard	Cleanroom	Waterproof
Protection degree *1			IP20	ISOclass5 *5	IP65 *6
Installation			Ceiling type		
Structure			Horizontal multiple-joint type		
Degrees of freedom			4		
Drive system			AC servo motor		
Position detection method			Absolute encoder		
Maximum load capacity		kg	Maximum 3 (Rated 1)		
Arm length	NO1 arm	mm	175		
	NO2 arm	mm	175		
Maximum reach radius		mm	350		
Operating range	J1	deg	450 (± 225)		
	J2	deg	450 (± 225)		
	J3 (Z)	mm	150	120	
	J4 (θ)	deg	1440 (± 72)		
Maximum speed	J1	deg/sec	672		
	J2	deg/sec	708		
	J3 (Z)	mm/sec	1500		
	J4 (θ)	deg/sec	3146		
Maximum composite speed *2		mm/sec	6267		
Cycle time *3		sec	0.32		
Position repeatability	Y-X composite	mm	± 0.01		
	J3 (Z)	mm	± 0.01		
	J4 (θ)	deg	± 0.01		
Ambient temperature		$^\circ\text{C}$	0 to 40		
Mass		kg	24	28	
Tolerable amount of inertia	Rating	kgm ²	0.005		
	Maximum	kgm ²	0.05		
Tool wiring			Gripper: 8 input points (up to 4 points for shaft) / 8 output points, 8 spare lines		
Tool pneumatic pipes			Primary: $\phi 6 \times 2$ Secondary: $\phi 4 \times 8$		
Machine cable			5m (connector on both ends)		
Connected controller *4			CR800-D, CR800-R, CR800-Q		

► External Dimensions/Operating Range Diagram

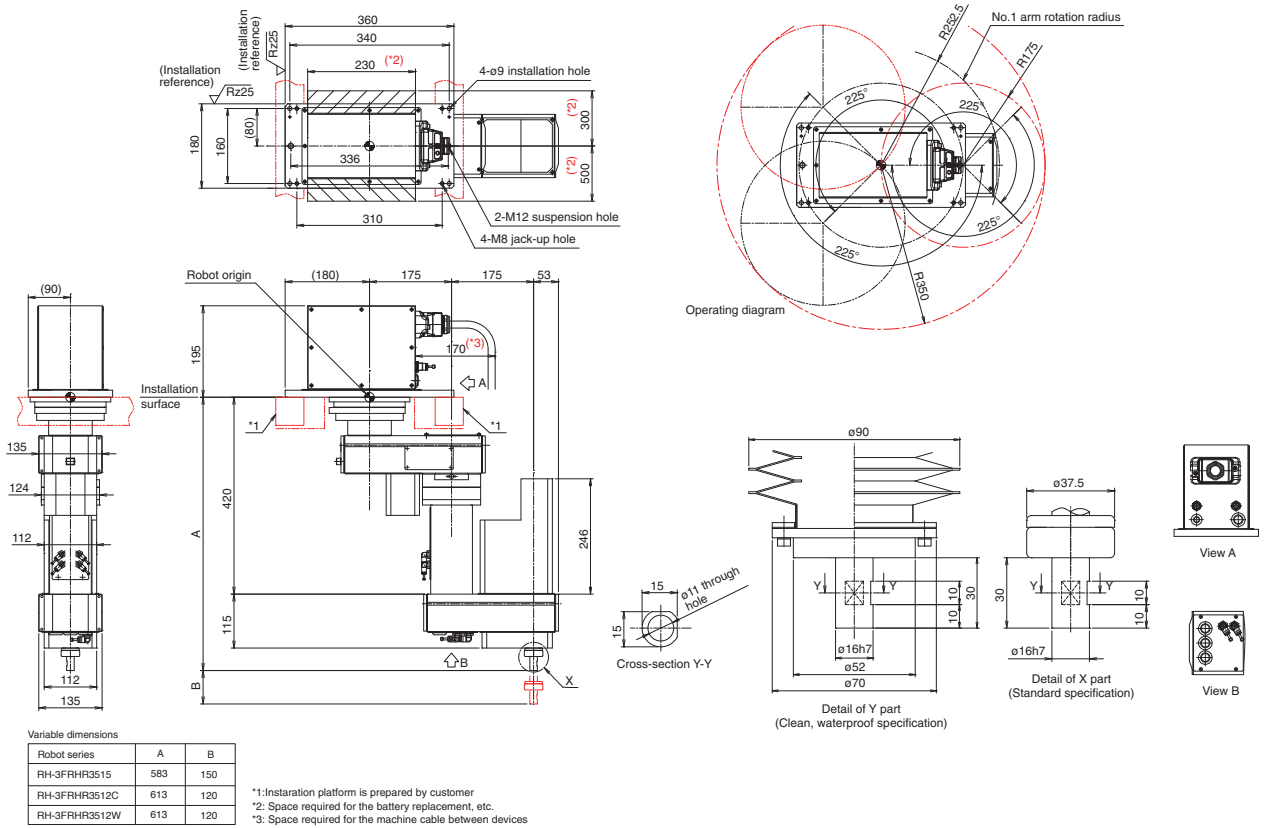

Waterproof specification

- IP65-rated and can be washed with water
 - Uses food-grade grease (NSF H1)*1
 - Prevents any peeling of the coating (coating-free)
- *1: Hygiene-related guidelines from the US NSF (National Sanitation Foundation)

Cleanroom specification

- ISO Class 5 cleanliness
 - Suitable for clean environments, such as transporting electrical/electronic components and pharmaceutical products.
 - Wiring and tubing can be installed internally in the tip.
- Prevents contamination produced by problems such as cable twisting or abrasion

► Features

Reduced equipment space

By suspending the machine from the ceiling, wasted space is eliminated and less space is needed for the entire installation.

RH-3FRHR work area
(Plan view: Cylinder shape)

Range of movement for a horizontal, multiple-joint type robot
(Plan view)

Easy installation and startup

(1) Constructed so that it can be suspended from fittings installed on top of the ceiling joists, making installation simple.

(2) Internal gripper tubing channels are provided in the tip axis, making tube installation easy and eliminating the problem of tangled tubes. (Handles up to 4 inside the shaft.)

(3) When a compact system starts up that is contained within the robot's maximum range of movement, the cylindrical movement range limitation function can be used to ensure that robot movement does not extend beyond the specified cylindrical range, allowing startup adjustment to be made without having to worry about interference.

In the normal movement range the arm strikes the pillar.

No interference

Movement restricted to cylindrical limit

*1: The environmental resistance specifications (C: Cleanroom specifications, W: Waterproof specifications) for the RH-3FRHR is factory-set custom specifications.
*2: The value assumes composition of J1, J2, and J4.
*3: Value for a maximum load capacity of 1 kg. The cycle time may increase if specific requirements apply such as high work positioning accuracy, or depending on the operating position.
(The cycle time is based on back-and-forth movement over a vertical distance of 25 mm and horizontal distance of 300 mm.)
*4: Select either controller according to your application. CR800-D: Standalone type, CR800-R: MELSEC iQ-R compatible type, CR800-Q: MELSEC Q Series compatible type.
*5: Preservation of cleanliness levels depends on conditions of a downstream flow of 0.3 m/s in the clean room and internal robot suctioning. A ø8-mm coupler for suctioning is provided at the back of the base.
*6: Direct jet to the bellows is excluded.

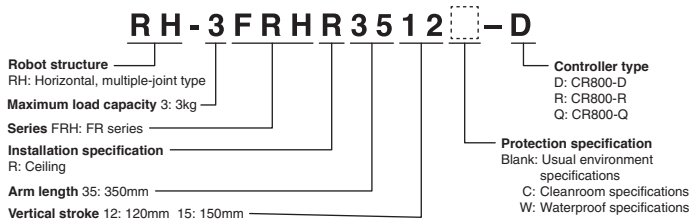

MELFA Controller CR800-R/Q/D

CR800-R
CR800-Q
CR800-D

MELSEC iQ-R/Q compatible robot controller

Uses a multi-CPU configuration that dramatically improves its interaction with FA equipment and also offers highly precise control and fast yet simple information management.

Standalone type robot controller

Can be constructed as the control nucleus for robot controllers.



CR800-R



CR800-Q



CR800-D



Specifications

Type	Unit	CR800-R	CR800-Q	CR800-D
Robot CPU		R16RTCPU	Q172DSRCPU	Built-in
Path control method		PTP control and CP control		
Number of axes controlled		Maximum 6 axes + additional 8 axes available		
Robot language		MELFA-BASIC V, VI		
Position teaching method		Teaching method, MDI method		
Memory capacity	Number of teaching points	points	39000	26000
	Number of steps	step	78000	52000
	Number of programs	unit	512	
External input/output	General-purpose I/O	points	0 input/0 output (8192 input points/8192 output points with the multiple CPU common device)	
	Dedicated I/O	points	Assigned to multiple CPU common device	
	Gripper open/close	points	8 input / 8 output *6	
	Emergency stop input	points	1 (redundant)	
	Door switch input	points	1 (redundant)	
	Enabling device input *7	points	1 (redundant)	
	Emergency stop output	points	1 (redundant)	
	Mode output	points	1 (redundant)	
	Robot error output	points	1 (redundant)	
	Synchronization of additional axes	points	1 (redundant)	
Interface	Encoder input	channels	2	Q173DPX (optional) 2
	RS-422	ports	1 (dedicated T/B)	
	Ethernet	ports	1 (dedicated T/B) 1 (for customer) 10BASE-T/100BASE-TX/1000BASE-T Correspondence with CC-Link IE Field Basic (Ver.A1d or later)	
	USB *5	ports	1 (USB port of programmable controller CPU unit)	1 (Ver. 2.0 device functions only, mini B terminal)
	Additional-axis interface	channels	1 (SSCNET III/H)	
	Extension slot *1	slots	1 (Available only for function expansion option card)	2
	R/C communication interface	channels	—	
	Remote I/O	channels	1 (Ver.2)	
Power supply	Memory extension slot	slots	—	
	Ambient temperature	°C	0 to 40 (controller) / 0 to 55 (robot CPU)	
Relative humidity	%RH	45 to 85		
Power supply	Input voltage range *2	V	RV-2FR/4FR/7FR, RH-3FRH/3FRHR/6FRH/12FRH/20FRH: Single-phase AC 200V to 230V RV-13FR/20FR/7FRLL, RH-1FRHR: Three-phase AC 200V to 230V or Single-phase AC 230V	
	Power capacity *3	KVA	RV-2FR, RH-3FRH: 0.5 RH-3FRHR, RV-4FR, RH-6FRH: 1.0 RH-12FRH/20FRH: 1.5 RV-7FR (except RV-7FRLL): 2.0 RV-7FRLL, RV-13FR, RV-20FR: 3.0	
External dimensions (including legs)	mm	430(W) × 425(D) × 99.5(H)		
Weight	kg	Approx. 12.5		
Structure [protective specification]		Self-contained floor type/open structure (Vertical and horizontal position can be placed) [IP20]		
Grounding *4	Ω	100 or less (class D grounding)		

*1: For installing option interface.

*2: The rate of power-supply voltage fluctuation is within 10%.

*3: The power capacity indicates the rating for normal operation. Take note that the power capacity does not include the current being input when the power is turned on. The power capacity is only a rough guide and whether or not operation can be guaranteed depends on the input power-supply voltage.

*4: Grounding works are the customer's responsibility.

*5: Recommended USB cable (USB A-to-USB mini B): MR-J3USBCBL3M (Mitsubishi Electric), GT09-C30USB-5P (Mitsubishi Electric System & Service Co., Ltd)

*6: RV-2FR series has 4 inputs and 4 outputs.

*7: Mode selection switch provided by the customer.

Controller

CR800-R/CR800-Q

External Dimensions

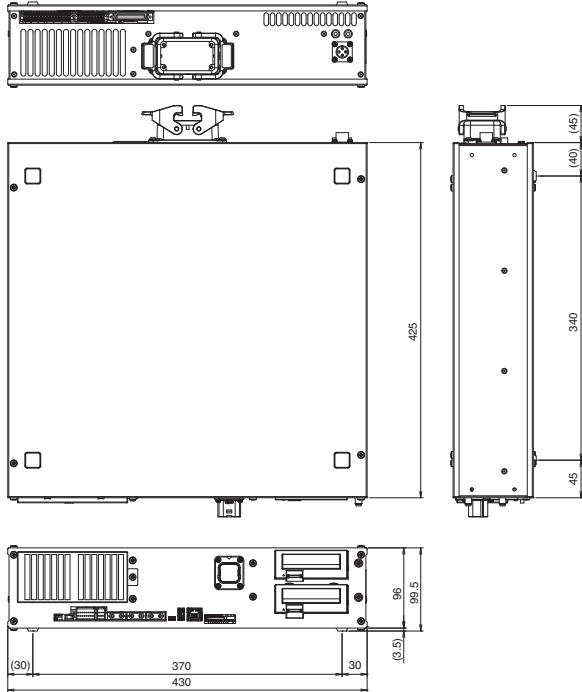

CR800-D

External Dimensions

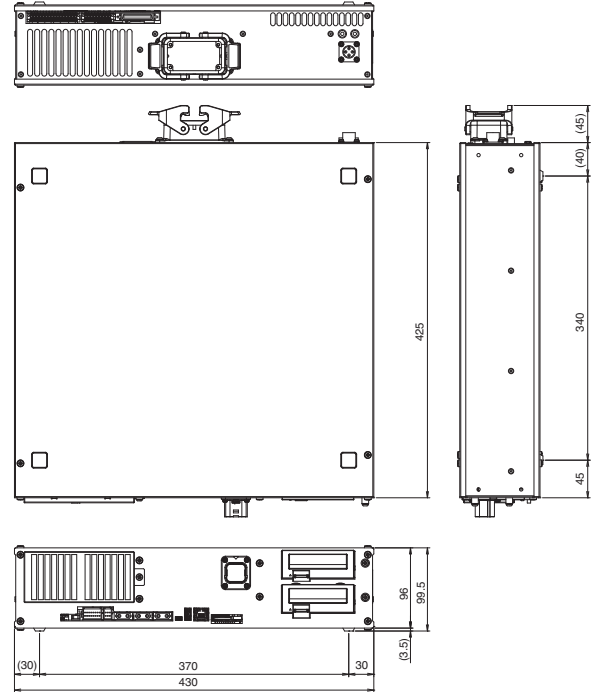

R16RTCPU

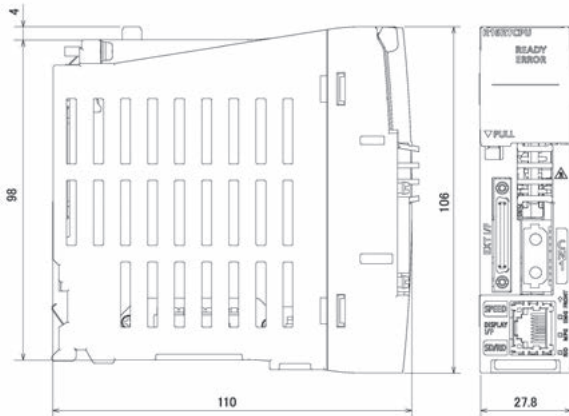

Q172DSRCPU

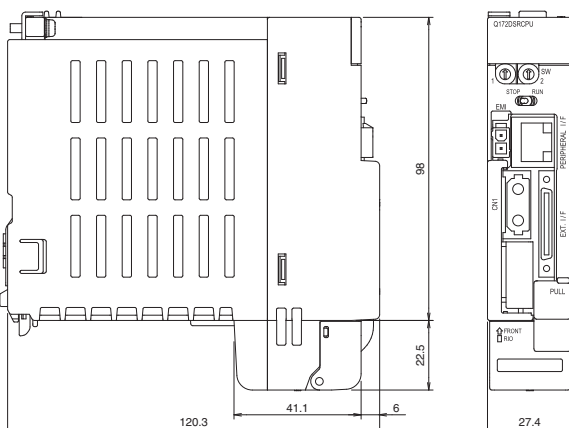

Multiple CPU environment

<CR800-R>

Unit	Type
Base	R35B 5-slot
	R38B 8-slot
	R312B 12-slot
Power supply	R61P
	R62P
	R63P
	R64P
PLC CPU	R00CPU
	R01CPU
	R02CPU
	R04CPU
	R08CPU
	R16CPU
	R32CPU
	R120CPU

<CR800-Q>

Unit	Type
Base	High-speed standard base between multiple CPU
	Q35DB 5-slot
	Q38DB 8-slot
Power supply	Q312DB 12-slot
	Q61P
	Q62P
	Q63P
PLC CPU	Q64PN
	Universal Model
	Q03UD(E/V)CPU
	Q04UD(E/V)HCPU
	Q06UD(E/V)HCPU
	Q10UD(E)HCPU
	Q13UD(E/V)HCPU
	Q20UD(E)HCPU
Q26UD(E/V)HCPU	
	Q100UD(E)HCPU

Note) For details of the PLC units, refer to the PLC manual or the Mitsubishi Electric FA website, etc.

OPTIONS

Robot arm options (RV)

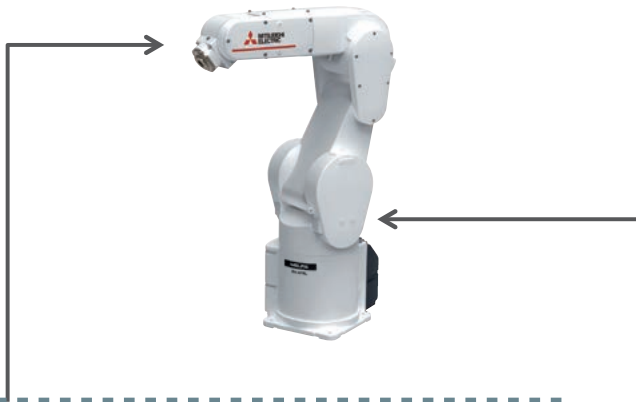

Solenoid valve set (sink/source type) ①

With dedicated hand output cable
1 to 4 valves



Hand output cable ②

Used when solenoid valves are provided by the customer



Hand input cable ③

For gripper sensor signal input



Hand curl tube ④

Tube for pneumatic grippers (1 to 4 tubes)



Machine cable (standard)

Fixed 5 m



Machine cable (replacement) ⑦

Fixed 2, 10, 15 or 20 m

Flexible 10, 15 or 20 m



J1 axis movement range modification

J2 axis movement range modification (RV-2FR series)

J3 axis movement range modification (RV-2FR series)

To be installed by the customer.

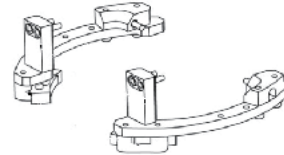

Cable outlets in the machine ⑥

- Forearm external wiring set
- Base external wiring set

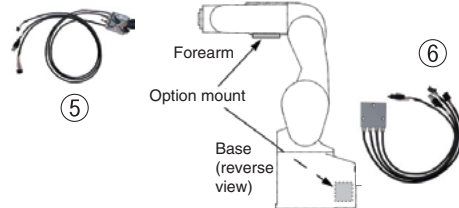

Internal wiring/ tubing specifications

The factory default specification is for wiring/tubing to be routed internally to the wrist with an outlet from the mechanical interface.



RV-FR Mechanical Options

No.	Name	Type	RV					Specifications
			2FR 2FRL	4FR 4FRL	7FR 7FRL	7FRLL	13FR 13FRL 20FR	
①	Solenoid valve set	1E-VD0□ (sink) 1E-VD0□E (source)	○	—	—	—	—	1 to 2 valves with solenoid valve cable. □ indicates the number of valves (1 or 2); output: 4ø
		1F-VD0□-02 (sink) 1F-VD0□E-02 (source)	—	○	○	○	—	1 to 4 valves with solenoid valve cable. □ indicates the number of valves (1, 2, 3, 4); output: 4ø
		1F-VD0□-03 (sink) 1F-VD0□E-03 (source)	—	—	—	—	○	1 to 4 valves with solenoid valve cable. □ indicates the number of valves (1, 2, 3, 4); output: 6ø
②	Hand output cable	1E-GR35S	○	—	—	—	—	Straight cable for 2-valve systems, robot connector on one end, unterminated on the other. Total length: 350 mm
		1F-GR35S-02	—	○	○	○	○	Straight cable for 4-valve systems, robot connector on one end, unterminated on the other. Total length: 500 mm
③	Hand input cable	1S-HC30C-11	○	—	—	—	—	4-point type, with a robot connector on one side and unterminated on the other.
		1F-HC35S-02	—	○	○	○	○	4-point type, with a robot connector on one side and unterminated on the other. Total length: 1000 mm
④	Hand curl tube	1E-ST040□C	○	○	○	○	—	For 1- to 4-ø4-valve systems; total length: 630 mm (including 180 mm curled section) □ indicates No. of tubes (2, 4, 6 or 8), 2 or 4 only in the RV-2FR and RV-2FRL
		1N-ST060□C	—	—	—	—	○	For 1- to 4-ø6-valve systems; total length: 1150 mm (including 250 mm curled section) □ indicates No. of tubes (2, 4, 6 or 8)
⑤	Forearm external wiring set 1	1F-HB01S-01	—	○	○	○	○	For the forearm. External wiring box used for connecting the gripper input cable, Ethernet cable and the electric gripper and force sensor cable.
	Forearm external wiring set 2	1F-HB02S-01	—	○	○	○	○	For the forearm. External wiring box used for connecting the force sensor, electric gripper and Ethernet cable.
⑥	Base external wiring set 1	1F-HA01S-01	—	○	○	○	○	For the base. External wiring box used for connecting the electric gripper communications output, electric gripper and force sensor cable and Ethernet cable. Includes gripper input.
	Base external wiring set 2	1F-HA02S-01	—	○	○	○	○	For the base. External wiring box used for connecting the electric gripper communications output, electric gripper, force sensor and Ethernet cable. No gripper input.
⑦	Machine cable (replacement) (fixed)	1F-□□UCBL-41	○	○	○	○	○	Replacement type, 2, 10, 15 or 20 m □□ indicates cable length (02, 10, 15 or 20 m)
	Machine cable (replacement) (flexible)	1F-□□LUCBL-41	○	○	○	○	○	Replacement type, 10, 15 or 20 m □□ indicates cable length (10, 15 or 20 m)
⑧	J1 axis movement range modification	1S-DH-11J1	○	—	—	—	—	Stopper for changing the range, installed by customer
		1F-DH-05J1	—	—	—	○	○	Stopper for changing the range, installed by customer (Also compatible with RV-7FRLL)
		1F-DH-04	—	—	○	—	—	Stopper for changing the range, installed by customer
	1F-DH-03	—	○	—	—	—	Stopper for changing the range, installed by customer	
	J2 axis movement range modification	1S-DH-11J2	○	—	—	—	—	Stopper for changing the range, installed by customer
J3 axis movement range modification	1S-DH-11J3	○	—	—	—	—	Stopper for changing the range, installed by customer	

RV-4FR/7FR/13FR/20FR series tooling machine configurations

The required options differ depending on the gripper (tool) configuration. The table below lists the "Forearm external wiring sets" and "Base external wiring sets" required for the different gripper configurations. Select wiring sets accordingly.

Gripper configuration	Wiring mode	Body specifications	Required equipment		Comment
			Forearm external wiring set	Base external wiring set (*3)	
•Pnumatic gripper + gripper input signals	Internal	-SH01	— (*1)	—	Air tubes: Up to 2 sets (4ø × 4), 8 input signals
	Externa	Standard	— (*2)	—	Air tubes: Up to 4 sets (4ø × 8)
•Pnumatic gripper + gripper input signals •Vision sensor	Internal	-SH05	— (*1)	(1F-HA01S-01)	Air tubes: Up to 1 set (4ø × 2), 8 input signals
	Externa	Standard	1F-HB01S-01 (*2)	1F-HA01S-01	Air tubes: Up to 4 sets (4ø × 8)
•Pnumatic gripper + gripper input signals •Force sensor	Internal	-SH04	— (*1)	(1F-HA01S-01)	Air tubes: Up to 1 set (4ø × 2), 8 input signals
	Externa	Standard	1F-HB01S-01 (*2)	1F-HA01S-01	Air tubes: Up to 4 sets (4ø × 8)
•Pnumatic gripper + gripper input signals •Vision sensor •Force sensor	Internal (External air tubes)	-SH02	— (*1)	(1F-HA01S-01)	External air tubes: Up to 4 sets (4ø × 8)
	Externa	Standard	1F-HB01S-01	1F-HA01S-01	Air tubes: Up to 4 sets (4ø × 8)
•Electric gripper + gripper input signals •Vision sensor	Internal	-SH02	—	(1F-HA01S-01)	
	Externa	Standard	1F-HB01S-01	1F-HA01S-01	
•Electric gripper •Vision sensor •Force sensor	Internal	-SH03	—	(1F-HA02S-01)	
	Externa	Standard	1F-HB02S-01	1F-HA02S-01	

*1: For pnumatic grippers with internal wiring, solenoid valves should be provided.

*2: For pnumatic grippers with external wiring, solenoid valves, tubing and input cables, etc. should be provided as necessary.

*3: For machines with internal wiring and tubing, a base external wiring set is included with the machine and does not need to be provided separately.

OPTIONS

Robot arm options (RH)



① Solenoid valve set (sink/source type)

With dedicated hand output cable
1 to 4 valves



② Hand output cable

Used when solenoid valves are provided
by the customer



③ Hand input cable

For gripper sensor signal input



④ Hand curl tube

Tube for pneumatic grippers (1 to 4 tubes)



⑤ Hand tube (for RH-3FRHR series)

Tube for pneumatic grippers (2 tubes)



Machine cable (standard)

Fixed 5 m



Machine cable (replacement)

Fixed 2, 10, 15 or 20 m

Flexible 10, 15 or 20 m

⑧



J1 axis movement range modification J2 axis movement range modification

To be installed by the customer.

⑨

⑥ Internal wiring and tubing set for grippers

An air tube and cable set used to run air tubes
and gripper input signal cables from inside
the second arm to the shaft tip

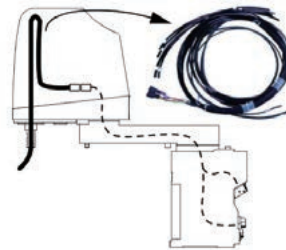

⑦ External wiring and tubing box

A useful option for taking air tubes and signal
wires out from the back end of the second arm or
running gripper wiring and/or tubing outside the robot

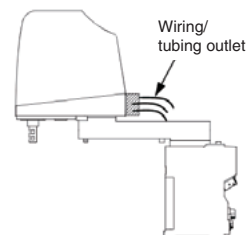

RH-FR Main Options

No.	Name	Type	RH				Specifications
			3FRH	6FRH	12FRH 20FRH	3FRHR	
①	Solenoid valve set	1F-VD0□-01 (Sink) 1F-VD0□E-01 (Source)	○	○	—	—	1 to 4 valves with solenoid valve cable. □ indicates the number of valves (1, 2, 3, 4); output: 4ø
		1S-VD0□-01 (Sink) 1S-VD0□E-01 (Source)	—	—	○	—	1 to 4 valves with solenoid valve cable. output: 6 mm dia. (standard)
		1S-VD04-05 (Sink) 1S-VD04E-05 (Source)	—	—	—	○	4 valves with solenoid valve cable. □ indicates the number of valves (1, 2, 3, 4); output: 6ø
		1S-VD04W-05 (Sink) 1S-VD04WE-05 (Source)	—	—	—	○	4 valves with solenoid valve cable. Output: ø4 (cleanroom specification / waterproof specification)
②	Hand output cable	1F-GR60S-01	○	○	○	—	For 4-valve systems, robot connector on one end, unterminated on the other, with drip-proof grommet Total length 1,050 mm, straight CBL
		1S-GR35S-02	—	—	—	○	Straight cable for 4-valve systems, robot connector on one end, unterminated on the other. Total length: 450 mm
③	Hand input cable	1F-HC35C-01	○	○	—	—	8-point type, with a robot connector on one side and unterminated on the other, equipped with a splash-proof grommet. Total length: 1800 mm (including 350 mm curled section)
		1F-HC35C-02	—	—	○	—	8-point type, with a robot connector on one side and unterminated on the other, equipped with a splash-proof grommet. Total length: 1650 mm (including 350 mm curled section)
		1S-HC00S-01	—	—	—	○	4-point type, with a robot connector on one side and unterminated on the other, equipped with a splash-proof grommet. Total length: 1210 mm
④	Hand curl tube	1E-ST0408C-300	○	○	—	—	For 4-ø4-valve systems; total length: 1000 mm (including 300 mm curled section)
		1N-ST0608C-01	—	—	○	—	For 1- to 4-ø6-valve systems; total length: 630 mm (including 250 mm curled section)
⑤	Hand tube	1S-ST0304S	—	—	—	○	3 mm dia. for 2 tubes (customer-usable length: 400 mm)
⑥	Internal wiring and tubing set for grippers	1F-HS604S-01	—	—	○	—	Internal wiring and tubing set for the tip axis (8 gripper inputs + two 6 mm dia. tubes) For 350 mm Z-axis stroke
		1F-HS604S-02	—	—	○	—	Internal wiring and tubing set for the tip axis (8 gripper inputs + two 6 mm dia. tubes) For 450 mm Z-axis stroke
		1F-HS408S-01	—	○	—	—	Internal wiring and tubing set for the tip axis (8 gripper inputs + four 4 mm dia. tubes) For 200 mm Z-axis stroke
		1F-HS408S-02	—	○	—	—	Internal wiring and tubing set for the tip axis (8 gripper inputs + four 4 mm dia. tubes) For 340 mm Z-axis stroke
		1F-HS304S-01	○	—	—	—	Wiring and piping set for internal mounting in the tip axis (compatible with 4 input points for gripper systems+ø3-2 solenoid valve systems)
⑦	External user wiring and tubing box	1F-UT-BOX-01	—	—	○	—	External outlet box for user wiring (gripper input/output, gripper tubes)
		1F-UT-BOX	○	○	—	—	External outlet box for user wiring (gripper input/output, gripper tubes)
⑧	Machine cable (replacement) (fixed)	1F-□□UCBL-41	○	○	○	○	Replacement type, 2, 10, 15 or 20 m □□ indicates cable length (02, 10, 15 or 20 m)
	Machine cable (replacement) (flexible)	1F-□□LUCBL-41	○	○	○	○	Replacement type, 10, 15 or 20 m □□ indicates cable length (10, 15 or 20 m)
⑨	J1 axis movement range modification	1F-DH-02	—	—	○	—	Stopper for changing the range, installed by customer
		1F-DH-01	○	○	—	—	Stopper for changing the range, installed by customer
		1S-DH-05J1	—	—	—	○	Stopper for changing the range, installed by customer
	J2 axis movement range modification	1S-DH-11J2	—	—	—	—	Stopper for changing the range, installed by customer
		1S-DH-05J2	—	—	—	○	Stopper for changing the range, installed by customer

SYSTEM

R Type Controller

System Configuration

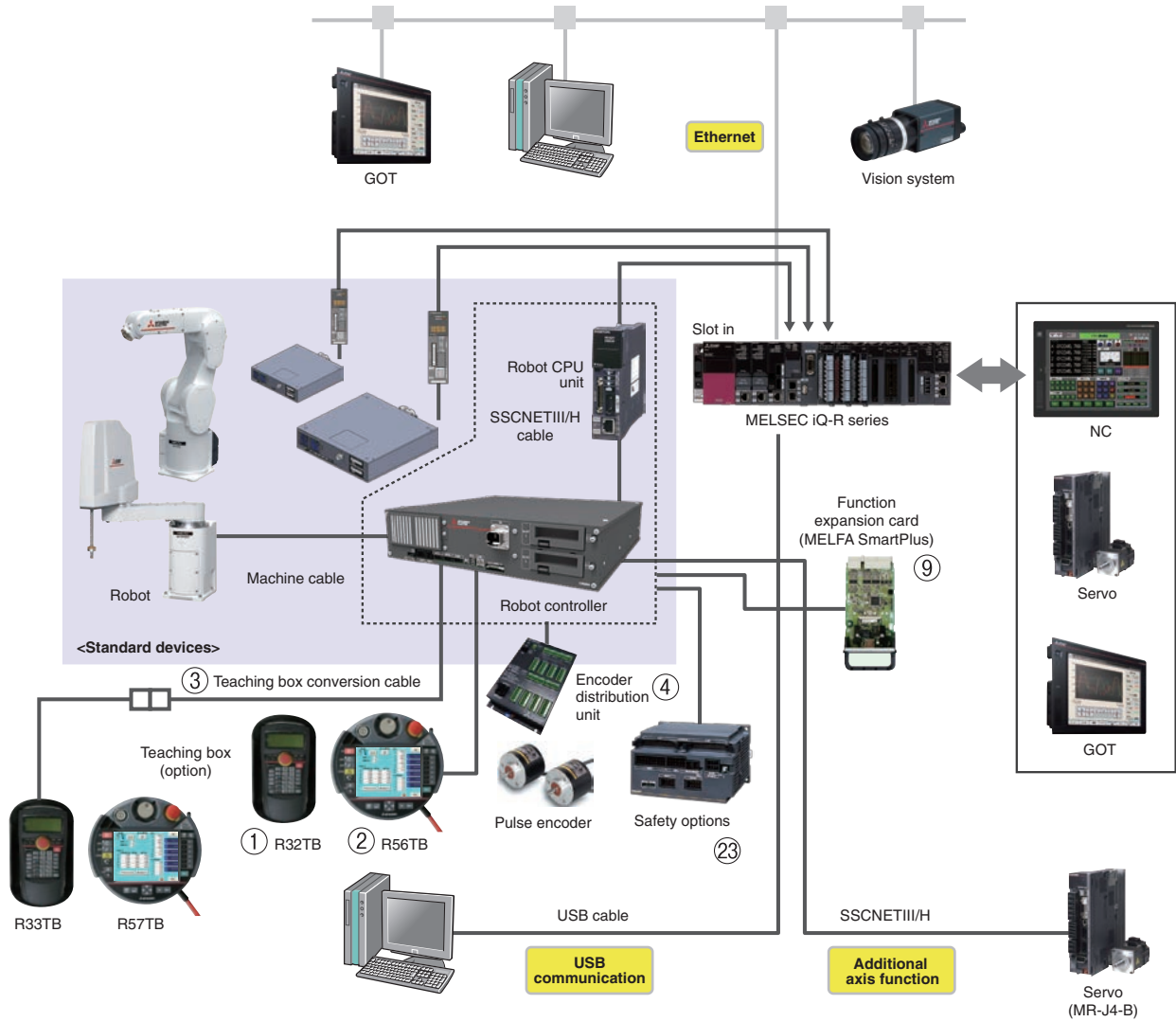

<Software options>



⑥
⑦
⑧

<Feature options>



⑳ Force sensor set



㉑ MELFA-3D Vision

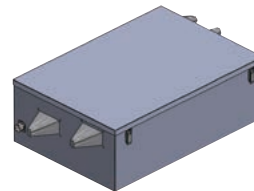

⑤ Controller protection box

OPTIONS (R Type Controller)

Option Configurations (Controllers)

No.	Name	Model	Specifications
①	Simple teaching box (7, 15 m)	R32TB (-**)	7 m: Standard; 15 m: Special (model name includes "-15")
②	High-performance teaching box (7, 15 m)	R56TB (-**)	7 m: Standard; 15 m: Special (model name includes "-15")
③	Teaching box conversion cable (33→32)	2F-33CON03M	Conversion cable for connecting the CR800 controller to the R33TB/R57TB. Cable length: 3 m
④	Encoder distribution unit	2F-YZ581	Unit used for connecting multiple controllers to one rotary encoder when using the tracking function (for 4 robots)
⑤	Controller protection box	CR800-MB	Houses a controller and provides protection against dust and water. (IP54)
⑥	Computer support software mini version	3F-15C-WINE	Simplified version (CD-ROM), (RT ToolBox3 mini)
⑦	Computer support software	3F-14C-WINE	With simulation function (CD-ROM), (RT ToolBox3)
⑧	Computer support software Pro version	3F-16C-WINE	Professional version (DVD-ROM), (RT ToolBox3 Pro)

Option Configurations (Functions)

No.	Name	Model	Specifications	
⑳	Force sensor set	4F-FS002H-W200	Set of devices required for force control functionality, including force sensors, interface unit and support software	
		4F-FS002H-W1000		
㉑	MELFA-3D Vision	4F-3DVS2-PKG1	Set of devices required for 3D vision sensor functionality, including 3D camera head and control unit (applicable machines: RV-FR series)	
		Additional camera head	4F-3DVS2-OPT1	For field-of-view expansion option
		Field-of-view expansion option	2F-3DVS2-OPT2	Expands the field of view by approx. 20° to 28°
㉒	Safety option	4F-SF002-01	Devices required by the safety functions	

Option Configurations (Software Expansion Functions)

No.	Name	Model	Specifications
㉓	MELFA Smart Plus Card Pack	2F-DQ510	Enables all A-type functions
		2F-DQ520	Enables all A and B-type functions
	MELFA Smart Plus Card	2F-DQ511	Selects and enables one function from A-type functions
		2F-DQ521	Selects and enables one function from A and B-type functions

Classification	Name	Type	Function outline
Intelligent function	Calibration assistance function	A	Assists with positional calibration with peripheral devices using 2D vision sensors
	Automatic calibration function		Provides a way to improve positioning accuracy by using automatically correcting the vision sensor coordinates
	Workpiece coordinate calibration function		Provides a way to improve positioning accuracy by using vision sensor to automatically correct the robot and workpiece coordinates
	Robot-to-robot relative calibration function		Uses vision sensors to adjust the relative locations of multiple robots. Provides a way to improve positioning accuracy during coordinated operation
	Robot mechanism temperature compensation function	A	Compensates thermal expansion of robot arm, and improves position accuracy
	Coordinated control for additional axis	A	Function for highly accurate coordination (interpolation) with additional axis (straight coaxial)
	Preventive maintenance function	A	Function for managing robot status by tracking operation status
AI function	MELFA 3D Vision expansion function	B	Automates 3D vision sensor parameter adjustment work, and improves measurement and recognition performance using AI technology

OPTIONS (Q Type Controller)

Option Configurations (Controllers)

No.	Name	Model	Specifications
①	Simple teaching box (7, 15 m)	R32TB (-**)	7 m: Standard; 15 m: Special (model name includes "-15")
②	High-performance teaching box (7, 15 m)	R56TB (-**)	7 m: Standard; 15 m: Special (model name includes "-15")
③	Teaching box conversion cable (33→32)	2F-33CON03M	Conversion cable for connecting the CR800 controller to the R33TB/R57TB. Cable length: 3 m
④	Controller protection box	CR800-MB	Houses a controller and provides protection against dust and water. (IP54)
⑤	Computer support software mini version	3F-15C-WINE	Simplified version (CD-ROM), (RT ToolBox3 mini)
⑥	Computer support software	3F-14C-WINE	With simulation function (CD-ROM), (RT ToolBox3)
⑦	Computer support software Pro version	3F-16C-WINE	Professional version (DVD-ROM), (RT ToolBox3 Pro)

Option Configurations (Functions)

No.	Name	Model	Specifications	
⑳	Force sensor set	4F-FS002H-W200	Set of devices required for force control functionality, including force sensors, interface unit and support software	
		4F-FS002H-W1000		
㉑	MELFA-3D Vision	4F-3DVS2-PKG1	Set of devices required for 3D vision sensor functionality, including 3D camera head and control unit (applicable machines: RV-FR series)	
		Additional camera head	4F-3DVS2-OPT1	For field-of-view expansion option
		Field-of-view expansion option	2F-3DVS2-OPT2	Expands the field of view by approx. 20° to 28°
㉒	Safety option	4F-SF002-01	Devices required by the safety functions	

Option Configurations (Software Expansion Functions)

No.	Name	Model	Specifications
⑧	MELFA Smart Plus Card Pack	2F-DQ510	Enables all A-type functions
		2F-DQ520	Enables all A and B-type functions
	MELFA Smart Plus Card	2F-DQ511	Selects and enables one function from A-type functions
		2F-DQ521	Selects and enables one function from A and B-type functions

Classification	Name	Type	Function outline
Intelligent function	Calibration assistance function	A	Assists with positional calibration with peripheral devices using 2D vision sensors
	Automatic calibration function		Provides a way to improve positioning accuracy by using automatically correcting the vision sensor coordinates
	Workpiece coordinate calibration function		Provides a way to improve positioning accuracy by using vision sensor to automatically correct the robot and workpiece coordinates
	Robot-to-robot relative calibration function		Uses vision sensors to adjust the relative locations of multiple robots. Provides a way to improve positioning accuracy during coordinated operation
	Robot mechanism temperature compensation function	A	Compensates thermal expansion of robot arm, and improves position accuracy
	Coordinated control for additional axis	A	Function for highly accurate coordination (interpolation) with additional axis (straight coaxial)
	Preventive maintenance function	A	Function for managing robot status by tracking operation status
AI function	MELFA 3D Vision expansion function	B	Automates 3D vision sensor parameter adjustment work, and improves measurement and recognition performance using AI technology

SYSTEM

D Type Controller

System Configuration

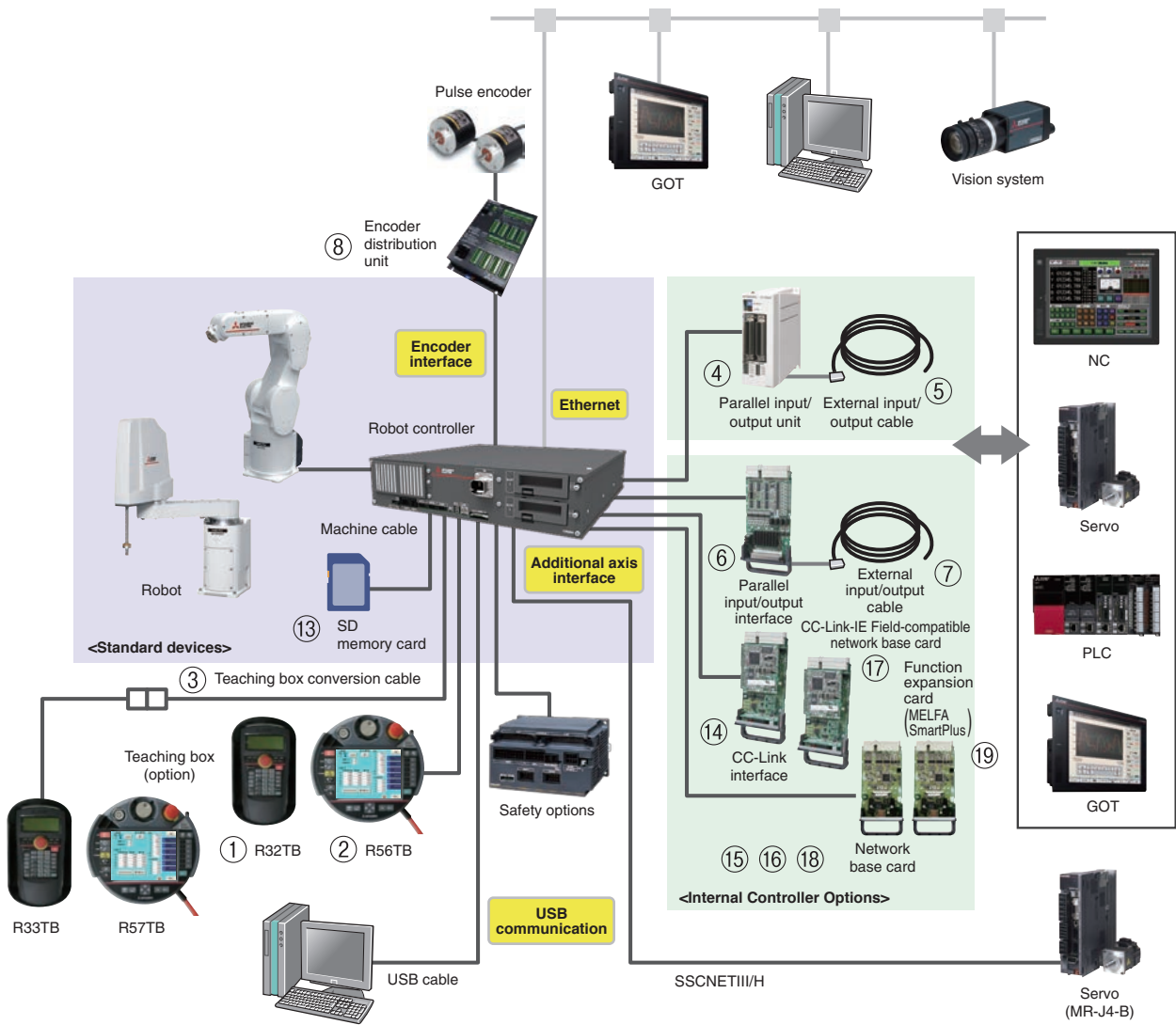

<Software options>



- RT ToolBox3 mini (10)
- RT ToolBox3 (11)
- RT ToolBox3 Pro (12)

<Feature options>

- Force sensor set (21)
- MELFA-3D Vision (22)

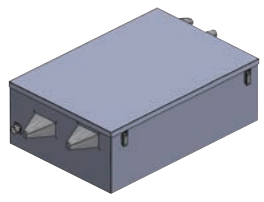

⑨ Controller protection box

OPTIONS (D Type Controller)

Option Configurations (Controllers)

No.	Name	Model	Specifications
①	Simple teaching box (7, 15 m)	R32TB (-**)	7 m: Standard; 15 m: Special (model name includes "-15")
②	High-performance teaching box (7, 15 m)	R56TB (-**)	7 m: Standard; 15 m: Special (model name includes "-15")
③	Teaching box conversion cable (33→32)	2F-33CON03M	Conversion cable for connecting the CR800 controller to the R32TB/R57TB. Cable length: 3 m
④	Parallel input/output unit	(sink type)	2A-RZ361
		(source type)	2A-RZ371
⑤	External input/output cable (5, 15 m)	2A-CBL**	CBL05: 5 m; CBL15: 15 m, one end unterminated. For 2A-RZ361/371
⑥	Parallel input/output interface (built-in)	(sink type)	2D-TZ368
		(source type)	2D-TZ378
⑦	External input/output cable (5, 15 m)	2D-CBL**	CBL05: 5 m; CBL15: 15 m, one end unterminated For 2D-TZ368/378
⑧	Encoder distribution unit	2F-YZ581	Unit used for connecting multiple controllers to one rotary encoder when using the tracking function (for 4 robots)
⑨	Controller protection box	CR800-MB	Houses a controller and provides protection against dust and water. (IP54)
⑩	Computer support software mini version	3F-15C-WINE	Simplified version (CD-ROM), (RT ToolBox3 mini)
⑪	Computer support software	3F-14C-WINE	With simulation function (CD-ROM), (RT ToolBox3)
⑫	Computer support software Pro version	3F-16D-WINE	Professional version (DVD-ROM), (RT ToolBox3 Pro)
⑬	SD memory card	2F-2GBSD	2 GB, logging
⑭	CC-Link interface	2D-TZ576	CC-Link intelligent device station Ver. 2.0, for 1–4 stations
⑮	Network base card (EtherNet/IP interface)	2D-TZ535	Communications interface for installation in an HMS Anybus-CompactCom module. HMS EtherNet/IP module (AB6314) to be provided by the customer.
⑯	Network base card (PROFINET interface)	2D-TZ535-PN	Communications interface for installation in an HMS Anybus-CompactCom module. HMS PROFINETIO module (AB6489-B) to be provided by the customer.
⑰	Network base card (CC-Link-IE Field interface)	2F-DQ535	Communications interface for installation in an HMS Anybus-CompactCom module. HMS CC-Link IE Field module (AB6709) to be provided by the customer.
⑱	Network base card (EtherCAT interface)	2F-DQ535-EC	Communications interface for installation in an HMS Anybus-CompactCom module. HMS EtherCAT (AB6707) to be provided by the customer.

Option Configurations (Functions)

No.	Name	Model	Specifications	
⑳	Force sensor set	4F-FS002H-W200	Set of devices required for force control functionality, including force sensors, interface unit and support software	
		4F-FS002H-W1000		
㉑	MELFA-3D Vision	4F-3DVS2-PKG1	Set of devices required for 3D vision sensor functionality, including 3D camera head and control unit (applicable machines: RV-FR series)	
		Additional camera head	4F-3DVS2-OPT1	For field-of-view expansion option
		Field-of-view expansion option	2F-3DVS2-OPT2	Expands the field of view by approx. 20° to 28°
㉒	Safety option	4F-SF002-01	Devices required by the safety functions	

Option Configurations (Software Expansion Functions)

No.	Name	Model	Specifications
⑲	MELFA Smart Plus Card Pack	2F-DQ510	Enables all A-type functions
		2F-DQ520	Enables all A and B-type functions
	MELFA Smart Plus Card	2F-DQ511	Selects and enables one function from A-type functions
		2F-DQ521	Selects and enables one function from A and B-type functions

Classification	Name	Type	Function outline
Intelligent function	Calibration assistance function	A	Assists with positional calibration with peripheral devices using 2D vision sensors
	Automatic calibration function		Provides a way to improve positioning accuracy by using automatically correcting the vision sensor coordinates
	Workpiece coordinate calibration function		Provides a way to improve positioning accuracy by using vision sensor to automatically correct the robot and workpiece coordinates
	Robot-to-robot relative calibration function		Uses vision sensors to adjust the relative locations of multiple robots. Provides a way to improve positioning accuracy during coordinated operation
	Robot mechanism temperature compensation function	A	Compensates thermal expansion of robot arm, and improves position accuracy
	Coordinated control for additional axis	A	Function for highly accurate coordination (interpolation) with additional axis (straight coaxial)
	Preventive maintenance function	A	Function for managing robot status by tracking operation status
AI function	MELFA 3D Vision expansion function	B	Automates 3D vision sensor parameter adjustment work, and improves measurement and recognition performance using AI technology

OPTIONS

Solenoid valve set



RH-3FHR and 6FHR
RH-12FHR and 20FHR

When grippers or various other tools are mounted on the end of the arm, this solenoid valve option is used to control those tools. Fitted with features such as manifolds, couplings and connectors to facilitate mounting on the robot body. The solenoid valve attachment shapes differ depending on the robot. Note the attachment shape before using.

Hand output cable

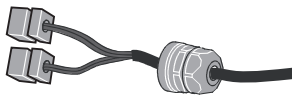

Cable size × No. of cores	AWG#24 (0.2 mm ²) × 12 cores
Total length:	300 mm (RV), 1050 mm (RH)

Useful for using solenoid valves other than the optional solenoid valve set. One end can be connected to the gripper signal output connector in the robot. The other end is unterminated (bare cable).

Hand input cable



Cable size × No. of cores	AWG#24 (0.2 mm ²) × 12 cores
Total length:	1000 mm (RV), 1650/1800 mm (RH: Includes a 350 mm curled section)

Used when the air gripper is designed by the customer. Used to convey gripper open/close confirmation signals and grip confirmation signals to the controller. One end can be connected to the gripper signal input connector on the top of the robot body. The other end is connected to a sensor in the gripper designed by the customer.

Hand curl tube

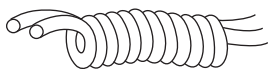

Material	Urethane
Size (mm)	4 mm dia. (external), 2.5 mm dia. (internal); length: 180 mm curled section, 250 + 200 mm straight section

Curl tube for air gripper.

Internal wiring and tubing set for grippers

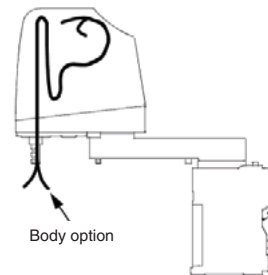

An air tube and cable set used to run input signal cables from inside the second arm to the shaft tip. An air tube and gripper input signal cable set. Includes grease (for applying to the upper part of the shaft), silicon rubber and cable ties.

External user wiring and tubing box

This is a useful option for taking air tubes and signal wires out from the back end of the second arm or running gripper wiring and/or tubing outside the robot. Features a coupling for exiting air tubes and a hole with cable clamps to secure exiting signal wires. Optional gripper output cables and gripper input cables can be secured.

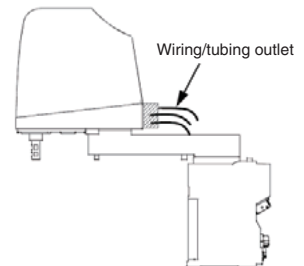

J1 axis movement range modification

	RV (*1)	RH
+J1	(Standard +240°) +210°, +150°, +90°	(Standard +170°) +150°, +130°
-J1	(Standard -240°) -210°, -150°, -90°	(Standard -170°) -150°, -130°

*1: For RV-2FR or RV-2FRL.
Refer to the specifications for information on other models.

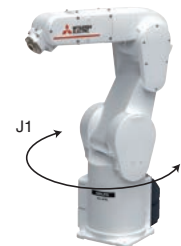

The J1 axis range of movement is limited by mechanical stoppers on the robot body and by the controller parameters. Use this feature when the range of movement needs to be limited due to problems such as interference with nearby devices.

Machine cable (replacement)



Fixed cable	2m, 10m, 15m or 20m
Flexible cable	10, 15 or 20 m; min. bend radius: 100 R or more

Used for replacement of the standard machine cable (5 m) included to extend the distance between robot controller and the robot main unit and connect it. There are 2 types of cables: fixed and flexible. Both type consists of motor signal cable and motor power cable.

OPTIONS

Simple teaching box

R32TB

External dimensions	195 (W) × 292 (H) × 106 (D) mm
Weight	Approx. 0.9 kg (body only, excluding cables)
Display	LCD type: 24 characters × 8 rows, backlit
Display languages	Japanese, English



Used for creating, editing and managing programs, to teach operating positions and for jogging. Fitted with a 3-position enabling switch to ensure safe use. When multiple robots are used, the connections can be switched to a single teaching box. The connections can be switched when the power is shut off.

High-performance teaching box

R56TB

See P.66 for details. →

External dimensions	252 (W) × 240 (H) × 114 (D) mm
Weight	Approx. 1.3 kg (body only, excluding cables)
Interface	USB port (1)
Display	6.5-Inch TFT (640 × 480) Color touch-screen, backlit
Display languages	Japanese, English



High-performance teaching box with improved monitor function in addition to the R32TB function.

Parallel input/output unit

<Input>

Model	DC input	
No. of input	32	
Isolation method	Photocoupler isolation	
Rated input voltage	12 V DC	24 V DC
Rated input current	Approx. 3 mA	Approx. 7 mA

<Output>

Model	Transistor output	
No. of outputs	32	
Isolation method	Photocoupler isolation	
Rated load voltage	12/24 V DC	
Maximum load current	0.1 A/output	



Used when external input/outputs are added. Connector cables for external devices are not included. External input/output cables (for parallel input/output units) are available as options. Both sink and source types are available.

Parallel input/output interface

<Input>

Model	DC input	
No. of input	32	
Isolation method	Photocoupler isolation	
Rated input voltage	12 V DC	24 V DC
Rated input current	Approx. 3 mA	Approx. 9 mA

<Output>

Model	Transistor output	
No. of outputs	32	
Isolation method	Photocoupler isolation	
Rated load voltage	12/24 V DC	
Maximum load current	0.1 A/output	



Installing this option on the controller allows external input/output to be used. Connector cables for external devices are not included. External input/output cables (for parallel input/output interfaces) are available as options. The input/output specifications are the same as for PLC interfaces. Both sink and source types are available.

External input/output cables (for parallel input/output units)

Cable size × No. of cores	AWG#28 × 25P (50 cores)
Total length:	5 or 15 m



This is a dedicated cable for connecting external peripheral devices to parallel input/output unit connectors. One end is matched to the parallel input/output unit and the other end is unterminated. Input/output signals from peripheral devices should be connected via the unterminated end of the cable. One cable supports 16 inputs and 16 outputs. If a parallel input/output unit is installed, 32 inputs and 32 outputs are connected per unit, so two cables must be added.

External input/output cables (for parallel input/output interfaces)

Cable size × No. of cores	AWG#28 × 20P (40 cores)
Total length:	5 or 15 m



This is a dedicated cable for connecting external peripheral devices to parallel input/output interface connectors. One end is matched to the parallel input/output interface and the other end is unterminated. Input/output signals from peripheral devices should be connected via the unterminated end of the cable. One cable supports 16 inputs and 16 outputs. If a parallel input/output interface is installed, 32 inputs and 32 outputs are connected per unit, so two cables must be added.

OPTIONS

CC Link Interface

Communication functions	Bit/word data transfer
Station type	Intelligent device station
Support station	Local station (no master station function)
CC-Link-compatible version	Ver.2, allows extended cyclic configuration
No. of isolated stations	Isolation of 1, 2, 3 or 4 stations can be configured



The CC-Link interface option augments CC-Link functionality by allowing cyclic transmission of word data as well as bit data to the robot controller.

CC-LinkIE Field-compatible network base card

Installation module	AB6709
Transmission specifications	1Gbps (1000BASE-T)
No. of inputs	Max. 2,048
No. of outputs	Max. 2,048



CC-Link IE Field communication can be achieved by having the customer install an HMS Anybus-CompactCom module (order code: AB6709) in the network base card (2F-DQ535).

EtherNet/IP-compatible network base card

Installation module	AB6314
Transmission specifications	10BASE-T/100BASE-TX
No. of inputs	Max. 2,048
No. of outputs	Max. 2,048



EtherNet/IP communication can be achieved by having the customer install an HMS Anybus-CompactCom module (order code: AB6314) in the network base card (2D-TZ535).

PROFINET-compatible network base card

Installation module	AB6489-B
Transmission specifications	100BASE-TX
No. of inputs	Max. 2040
No. of outputs	Max. 2040



PROFINET IO communication can be achieved by having the customer install an HMS Anybus-CompactCom module (order code: AB6489-B) in the network base card (2D-TZ535-PN).

EtherCAT-compatible network base card

Installation module	AB6707
Transmission specification	100Mbps (100BASE-TX)
No. of inputs	Bit device : Max. 256 points Word device: Max. 128 points
No. of outputs	Bit device : Max. 256 points Word device: Max. 128 points



EtherCAT communication can be achieved by having the customer mount an Anybus-CompactCom module (order code: AB6707) on the network base card (2F-DQ535-EC).

Safety option



Allows people to approach and enter the work area without stopping the robot.

Safety expansion unit	Input signal	8 systems (duplicated)
	Output signal	4 systems (duplicated)
	External dimensions	115 × 168 × 100mm
	Applicable robot controller	CR800-R/Q/D

Controller protection box

Houses a controller and provides protection against dust and water. (IP54)

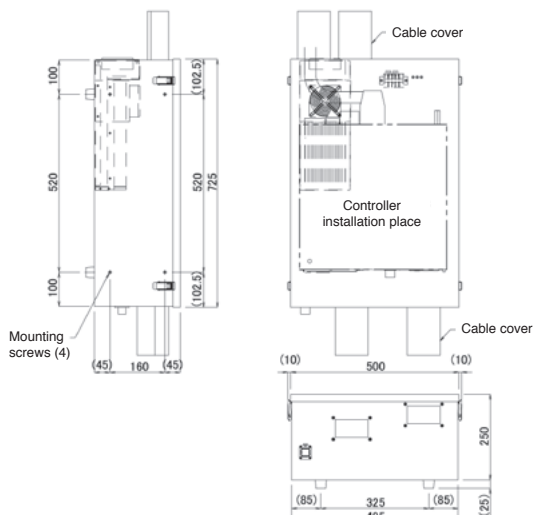

R56TB

Model R56TB

TFT color LED display provides colorful displays for greater ease of operations.

The new R56TB teaching box delivers enhanced robot operations.

Outfitted with monitoring functions on par with PC support software, it has become even easier to use to edit programs, set parameters, and display I/O status.

The touch panel GUI allows easy programming and monitoring, and switches arranged around the panel ensure efficient robot operations.

The teaching box is also equipped with a USB memory interface for backing up controller data without the use of a PC.

R56TB is...

An upgraded teaching box model to R32TB. In addition to "training" the robot, its LCD display and monitoring functions can be effectively used for debugging tasks.



Specifications/Functions

Item	Specification
External dimensions	252mm (W) × 240mm (H) × 114mm (D)
Body color	Dark gray
Weight	1.3kg (main unit only, excluding cable)
Connection method	Connection with controller using a dedicated connector
Interface	1 USB port
Display	6.5" TFT color LCD display; 4 status indicator LEDs
Operation panel	Touch panel, emergency stop button, enabling switch (3 positions), TB button, wheel, 30 operation keys
Display languages	Japanese, English

Features

Improved display performance



Menu display

- Adopts a VGA (640×480) full-color touchAh panel for user-friendly screen layouts.
- Visual menu screens ensure easy operations.

Functions on par with PC software



Program screens

- Program editing screens use a large layout (6.5") to display programs in an easy-to-understand fashion.
- Programs can be written and parameter names entered easily using the keyboard screen.
- Text can also be entered using a stylus pen.



Monitoring screens

- Program debugging time can be shortened via screen operations, such as the I/O monitor screen, which was not available with R32TB.

USB connection interface

By connecting USB memory, controller data may be backed up without the need to have a PC on site. Program information, parameter information, system information, and other such data may be backed up, as with a PC.

Enhanced user-friendliness



The teaching box can be held with one gripper by gripping the grip handle, and the enable switch operated with a finger on the same gripper. The other gripper can be used to operate the touch panel and buttons. The right and left grippers may be interchanged.

User-defined screen functions



Monitor screens may be individually created to suit each user's debugging task. Debugging time is shortened by being able to easily display the screen to monitor.

Operations panel



The robot operations screen provides the same functions as the robot controller panel, and may be used to activate such automated operations as servo on/off, start-up, shut-down, reset, and program selection.

Force Sensor Set

Model 4F-FS002H-W200/1000

Assembly/processing tasks are performed in the same manner as a human being, while sensing the force that is applied to the gripper. Tasks requiring subtle adjustment and detection of force can be performed.

Improved production stability

Parts can be inserted/attached without damage, while adjusting for displacement absorptions caused by parts variations and subtle external forces. Work stability is improved by position latching and retry processing at times of work failure. Furthermore, quality can be managed using log data, and the causes of work errors can be analyzed.

Realization of complex assembly and processing tasks

Parts can be inserted/attached without damage, while adjusting for subtle external forces. Action direction and pushing force can be changed by detecting the contact force, and interrupt processing can be performed using trigger conditions that combine position information and force information.

Easy control

Programs can be easily created using dedicated robot language. Based on representative examples of application programs, work programs can be easily created in response to each customer's required task.

Simple operations

The robot can be quickly "taught" accurate positions based on position and force data from the teaching box. Work conditions can be verified and adjusted by viewing the position and force data from the teaching box and the graph waveform on RT ToolBox3.



Product features

Item		Features	
Controller	Force control	Force control	Function for controlling robots while applying a specified force
		Stiffness control	Function for controlling the stiffness of robot appendages
		Gain changes	Function for changing control characteristics while the robot is running
	Force detection	Execution of interrupts	Interrupts can be executed (MO triggers) under trigger conditions combining position and force information.
		Data latch	Function for acquiring force sensor and robot positions while contact made
		Data reference	Function for display force sensor data and maintaining maximum values
	Force log	Synchronous data	Function for acquiring force sensor information synchronized to position information as log data and displaying it in graph form
		Start/stop trigger	Allows logging start/stop commands to be specified in robot programs
		FTP transmission	Function for transferring acquired log files to the FTP server
Teaching box	Force sense control	Enables/disables force sensor control and sets control conditions while jogging.	
	Force sense monitor	Displays sensor data and the force sense control setting status.	
	Teaching position search	Function for searching for the contact position.	
	Parameter setting screen	Parameter setting screen dedicated for the force sense function. (For R565B/R57TB)	

System Configuration

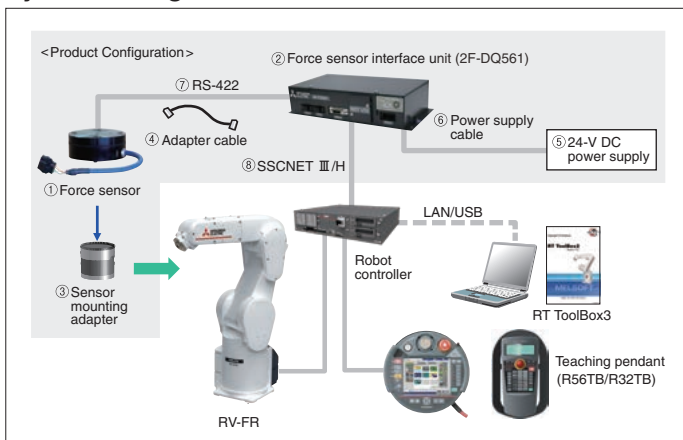

Product Configuration

Name	Qty.	Name	Qty.
① Force sensor	Qty. 1	⑤ 24V DC power supply	Qty. 1
② Force sensor interface unit	Qty. 1	⑥ 24V DC power supply cable	1m
③ Sensor adapter (*1)	Qty. 1	⑦ Serial cable between the unit and sensor	5m
④ Adapter cable	Qty. 1	⑧ SSCNET III cable	10m

*1 Not included in 4F-FS002H-W1000. An adapter needs to be selected from the chart at right and purchased separately in accordance with your robot model.

Force Sensor Specifications

Item	Unit	Specification Value		
Rated load	-	4F-FS002H-W200	4F-FS002H-W1000	
Max. static load	Fx, Fy, Fz	N	200	1000
	Mx, My, Mz	Nm	4	30
Breaking load	Fx, Fy, Fz	N	0.3	
	Mx, My, Mz	Nm	0.03	
Consumption current	mA	200		
Weight (sensor unit)	g	360	580	
External dimensions	mm	ø80×32.5	ø90×40	
Protective structure	-	IP30		

Force Sense Interface Unit Specifications

Item	Unit	Specification Value		
Interface	RS-422	ch	1 (For sensor connection)	
	SSCNET III/H	ch	1 (For robot controller and additional axis ampconnection)	
Power supply	Input voltage	Vdc	24±5%	
	Power consumption	W	25	
External dimensions	mm	225(W)×111(D)×48(H)		
Weight	kg	Approx. 0.8		
Construction	-	IP20 (Panel installation, opentype)		

Sensor mounting adapter (for 4F-FS002H-W1000)

Name of product	Model
Sensor mounting adapter (for RV-2/4/7FR)	1F-FSFLGSET-01
Sensor mounting adapter (for RV-13/20FR)	1F-FSFLGSET-02

* 4F-FS002H-W200 comes with a sensor mounting adapter (for RV-2/4/7FR).

MELFA-3D Vision 2.0 Model 4F-3DVS2-PKG3

This compact 3D vision sensor for small robots delivers high-speed, high-accuracy measurements. It is an optimum replacement for a parts feeder, and performs high-speed picking owing to its unique model-less recognition processing.

Compact and lightweight

The compact and lightweight body (camera head: 146×87×137 mm, approx. 0.9kg) is ideal for fixed installations and eye-in-gripper configurations.

High-speed, high-accuracy measurement

High-accuracy measurement is realized by a high-speed recognition of 0.2 seconds at the quickest (model-less recognition) and a minimum measuring error of approx. 0.3mm.

As a replacement for a parts feeder

One of two types of recognition methods may be selected.
 • Model-less recognition: The position of a workpiece is recognized without registering its model
 • Model matching recognition: Workpiece pose is recognized using a 3D-CAD model
 Compared to a parts feeder, the 3D vision sensor is less expensive and has a smaller footprint (when handling multiple parts). Retry operations can reduce frequent stoppages.

Connection compatibility befitting a robot manufacturer

Direct connection is possible via LAN, which is equipped on the controller as a standard feature, and sensor settings and operation checks can be made easily using a PC. The PC, however, is not needed while the sensor is operating. The sensor can calibrate the coordinates of the robot and vision sensor as a standard feature, and realize easy control by using dedicated commands that have been added to MELFA-BASIC.

Product specifications

Item	Specifications
Measurement method (*1)	Triangulation method (Pattern light projection type)
Measurement time	Approx. 1.3 to 1.8 seconds
Recognition method	Model-less: Workpiece registration-free method (6 degrees of freedom: XYZABC) Model matching: 3D-CAD utilizing method (6 degrees of freedom: XYZABC)
Processing time (*2)	Model-less: Approx. 1.2 to 2 seconds ⇒ Approx. 0.2 to 1.0 seconds * During measurement Model matching: Approx. 1 to 2.2 seconds ⇒ Approx. 0.9 to 1.5 seconds * During measurement
Measurement efficient points (*3)	Approx. 300000 to 600000 points
Measurement viewing angle (*3)	Approx. 15 to 20 degrees (standard field-of-view)/ Approx. 20 to 28 degrees (extended option field-of-view)
Workpiece distance (*4)	300 to 1000 mm
Measuring error (*3)	0.3 mm or more
External dimensions (*5)	Camera head section (Minimum size, W indicates 3-step variable) 146 (W) × 87 (H) × 137 (D) mm
Weight	Approx. 0.9 kg (Camera head part)
General specifications	Ambient temperature: 5 to 40°C (Camera head section: 0 to 40°C) Ambient humidity: 45 to 85%RH, with no condensation Usage atmosphere: With no corrosive gas
Power supply	24 V

*1) Shielding measures may be required depending on the usage environment, such as when surrounding environmental light affects the sensor.
 *2) The standard time from the recognition start to output. The process may take longer than the standard time depending on the conditions of surrounding environment, workpieces, and processing parameters.
 *3) The number of effective points varies depending on the conditions including the sensor installation distance and lens used.
 *4) The range of the distance between the lens installation flange face and a position to be measured. All areas cannot be used at the same time. For details, refer to instruction manuals.
 *5) The size of the camera head section depends on the mounting base in use.

Components

No.	Name	Quantity
1	Camera head (dedicated communication cable and power cable enclosed)	1
2	Mounting base set (Small: Mounted at shipment, medium, large)	1
3	Calibration jig	1
4	CD-ROM (MELFA-3D Vision software, instruction manual, setup guide, etc.)	1



Products prepared by customers

Name	Description	Quantity
Personal computer (3DV control IPC)	OS: Windows 10 Professional/Enterprise (64bit) ^(*) CPU: Intel Core i-7 (4 cores or more) RAM: 4[GB] or more / HDD: 100[GB] or more (*8[GB] or more is required when using MELFA Smart Plus.) Gigabit Ethernet port x 1	1 unit
Personal computer (for setting)	RT ToolBox3 installed (can be used with 1)	1 unit
Switching hub	1000BASE-T or later	1 unit
LAN cable	Category 5e or later	2 to 3 cables
24 VDC power supply	For camera head	1

Precautions

- The following workpieces cannot be measured.
 - Transparent objects and mirror face objects
- The following workpieces may be difficult to be measured or recognized.
 - High-gloss objects, black objects, or deep color objects
- Workpiece size (Reference values)
 Model-less: Short side = 1/25 of the viewing field size to Long side = 1/3 of the viewing field size
 Model matching: Short side = 1/10 of the viewing field size to Long side = 1/3 of the viewing field size
 *The workpiece size depends on the conditions of the workpiece distance, sensor parameters, and the shape and surface of the workpiece. The reference values are based on Mitsubishi test conditions. For details, refer to instruction manuals.
- Whether the measurement can be performed or not and the measurement accuracy depend on individual conditions. For details, please contact Mitsubishi.
- For model-less picking, a 2D vision sensor may be required in addition to a 3D vision sensor.
- The applicable model is the vertical, multiple-joint type RV-F Series.

Product configuration (MELFA-3D Vision 2.0)

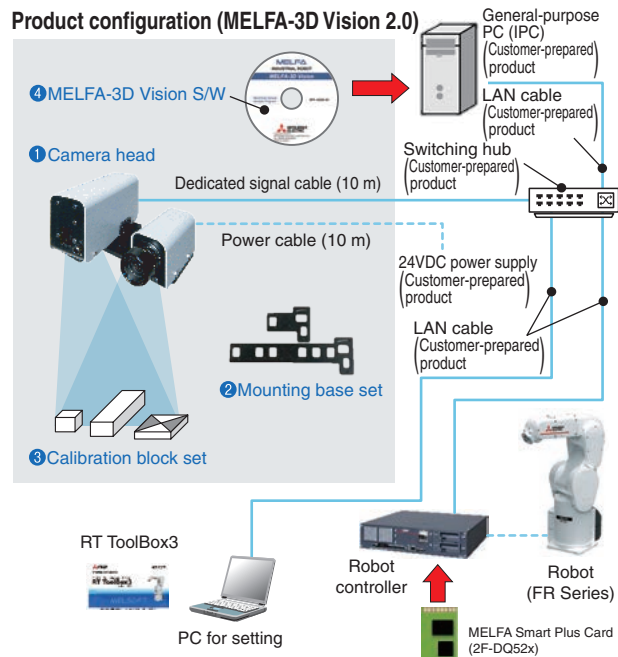

*Required only when using AI function

RT ToolBox3

Model 3F-14C-WINE/3F-15C-WINE

Software for program creation and total engineering support.

This is PC software that supports all processes from system startup to debugging and operations, including programming and editing, verification of the scope of operations prior to introducing a robot, estimation of tact time, robot debugging prior to startup, and monitoring of robot conditions and malfunctions during operations.

Windows® compatible

- Easy operations on Windows®
- Compatible with Windows®XP, Windows®Vista, Windows®7, 8, 8.1, 10 (32-bit version 1.8 or later, 64-bit version 2.0 or later)

Simulation functions

- Compatible with all models that connect to the CRn-500 Series, CRn-700 Series, CRn-750 Series, and CRn-800 Series controllers.
- Robot movements and tact times can be calculated using a PC (not available with the mini version).
- Robot movements, operational status, input signals, and servo conditions can be monitored.

Full support, from programming to startup and maintenance

- Programs can be edited using MELFA-BASIC IV, V and VI and (varies depending on the model).
- Robot movements, operational status, input signals, and servo conditions can be monitored.

Enhanced maintenance functions

- Equipped with a maintenance forecast function that notifies users of the robot's greasing time and battery life, and an assistance function for position recovery in the event of trouble, the software is effective for preventive maintenance and for shortening recovery time.
- Data is managed by project, to allow collective backup of the entire system.

Program editing and debugging functions

Programs are created using MELFA-BASIC IV, V and VI.*1
A multi-window format has been adopted for greater work efficiency and enhanced editing. Operations such as program step executions and breakpoint settings can be conveniently verified.

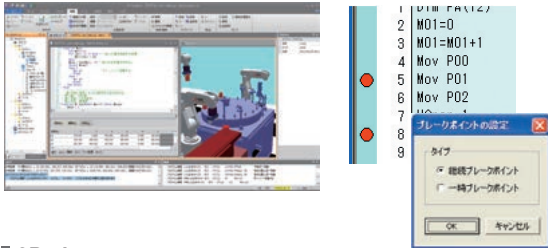

3D viewer

The 3D viewer allows easy verification of robot poses and movements, verification of the limit values of user-defined parameters, and virtual placements of peripheral devices by basic objects. It can also be used to check for interferences between the robot and peripheral devices. Distance measuring functions are also available on the screen.

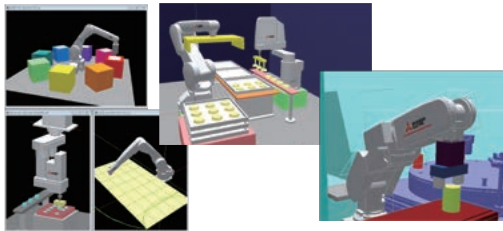

*1: MELFA BASIC is a language that has been developed based on the usability and user-friendliness of the widely-used conventional BASIC language, with the addition of commands needed for robot control. MELFA BASIC IV/V not only offers these additional commands, but also incorporates structuring and parallel processing functions that were difficult to realize with BASIC, for even greater ease of use and detailed control.

<Example of a Pick & Place program>

Mov Psafe	*Move to evasion point
Mov Pget,-50	*Move above workpiece extraction position
Mvs Pget	*Workpiece extraction position
Dly 0.2	*Wait 0.2 seconds
Hclose 1	*Close hand
Dly 0.2	*Wait 0.2 seconds
Mvs Pget,-50	*Move above workpiece extraction position
Wait M_In (12)=1	*Wait for signal
Mov Pput,-80	*Move above workpiece placement position
Mvs Pput	*Workpiece placement position
Dly 0.2	*Wait 0.2 seconds
Hopen 1	*Open hand
.....	

Classification	Main functions
Movements	Joint, linear, and circular interpolation, optimal acceleration/deceleration control, compliance control, collision detection, singular point passage
Input/output	Bit/byte/word signals, interrupt control
Numerical operations	Arithmetic calculation, pose (position), character strings, logic operations
Additional functions	Multi-tasking, tracking, vision sensor functions

Simulation functions

Programs that have been created can be executed in the PC, movements can be verified, and the tact times of specified parts of a program can be measured. Such simulation functions are also effective for preliminary system examinations. Servo simulations can also be performed, for preliminary examination of loads. Signals can be coordinated with GX works2 and GX works3 for easy creation of line simulators. A maximum of 8 robots can be operated, and coordinated movements among robots can be verified.

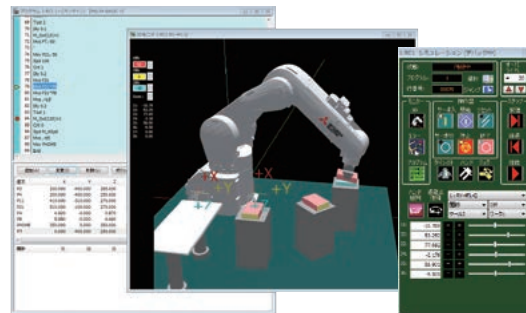

Monitoring functions

Program execution status, variables, I/O signals, etc. can be monitored.



Maintenance functions

Maintenance functions include maintenance forecasts, position recovery support, parameter management, etc.

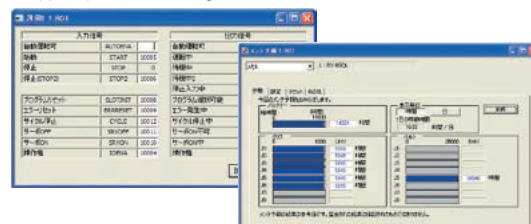

*Windows® is registered trademark of Microsoft Corporation in the United States and other countries.

RT ToolBox3 Pro

Model 3F-16D-WINE

A 3D robot simulator that provides powerful support for system designs and preliminary layout examinations.

RT ToolBox3 Pro allows robot simulations to be run on SolidWorks® 3D CAD software.

Programs can be created to match today's era of high-mix, low-volume production, such as for layout considerations prior to introducing robots, desktop program debugging, and generation of complex motion paths.

By linking an add-in tool to SolidWorks® 3D CAD software, robot simulation functions can be added on to SolidWorks® platform.

*1) SolidWorks® is a registered trademark of SolidWorks Corporation (USA).

*2) An add-in tool is a software program that adds certain functions to application software packages.

Features

Automatic robot program creation function

By loading 3D CAD data (*3) of the relevant workpiece to SolidWorks® and setting processing conditions and areas, teaching position data and robot movement programs that are necessary to operate the robot can be generated automatically. Programs can be automatically created even for workpieces with complex shapes that require multiple teaching position data.

*3) Formats that can be loaded into SolidWorks®

- | | |
|---|--|
| <input type="radio"/> IGES | <input type="radio"/> DXFTM |
| <input type="radio"/> STEP | <input type="radio"/> STL |
| <input type="radio"/> ParasolidR | <input type="radio"/> VRML |
| <input type="radio"/> SAT (ACISR) | <input type="radio"/> VDA-FS |
| <input type="radio"/> Pro/ENGINEER | <input type="radio"/> Mechanical Desktop |
| <input type="radio"/> CGR (CATIAgraphics) | <input type="radio"/> CADKEYR |
| <input type="radio"/> Unigraphics | <input type="radio"/> Viewpoint |
| <input type="radio"/> PAR (Solid Edge TM) | <input type="radio"/> RealityWave |
| <input type="radio"/> IPT (Autodesk Inventor) | <input type="radio"/> HOOPS |
| <input type="radio"/> DWG | <input type="radio"/> HCG (Highly compressed graphics) |

Note) See the SolidWorks website and other published information for the latest specifications.

Screen configuration

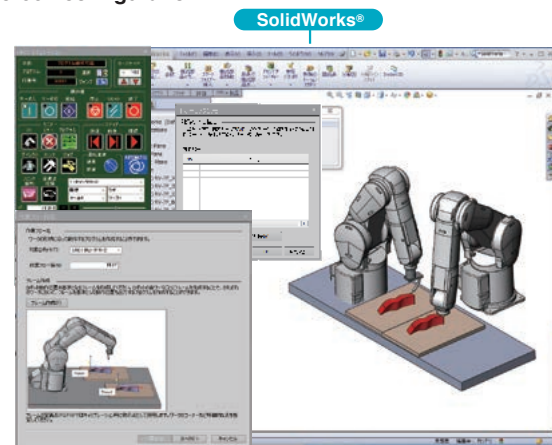

Calibration tool

List of functions

Data loading from peripheral devices and making rearrangements

Data of parts created with SolidWorks® can be loaded into the simulator. The loaded parts can be arranged relative to the CAD origin or other parts. They can also be rearranged by numerical input.

Installation of grippers

Grippers designed and created with SolidWorks® can be installed on selected robots. An Auto Tool Changer (ATC) can also be specified for each gripper.

Handling workpieces

Workpieces can be handled without fail by simulating gripper signal control using a robot program.

CAD links

Work data for performing sealing operations and other such tasks that require many teaching steps can be easily created by selecting the processing area on the 3D CAD data. Since work data is created from 3D CAD data, even complex 3D curves can be generated, and the number of teaching steps can be significantly reduced.

Offline teaching

Robot poses can be "taught" on screen, in advance.

Creation of robot programs (templates)

Workflows can be created by combining offline teaching and CAD links, and converted to robot programs (MELFA BASIC IV, V format).

Specifying robot programs

Robot programs may be used as they are without modifications, and can be specified for each task slot.

Simulation of robot operations

Robot programs, including I/O signals, can be simulated. That is, the operations of the actual system can be reproduced as they are. The I/O signals of a robot controller may be simulated according to two methods: (1) by defining movements associated with I/O signals in a simple manner, or (2) by linking robot programs with GX Simulator2/3.

Displaying robot trajectories

The trajectories of robot operations can be displayed by locus lines in space.

Interference checks

Interferences between the robot and peripheral devices can be checked. Items that are to be subject to an interference check may be specified simply by clicking on it on screen. If an interference is detected, information about the interference (name of the part, the program line that was executed and the position of the robot when the interference occurred, etc.) may be stored in a log file.

Saving videos

Simulated operations can be saved to a video file (AVI format).

Measurement of cycle times

The cycle time of robot operations can be measured in a manner resembling a stopwatch. The cycle time of specified locations of a program can also be measured.

Robot program debugging functions

The following functions are provided for debugging robot programs.

- **Stepped operation:** Specified programs are executed one step at a time.
- **Breakpoint:** Breakpoints can be inserted in a specified program.
- **Direct execution:** Arbitrary robot commands are executed.

Jog function

A robot displayed in SolidWorks® can be jogged, just as a teaching box can jog a robot.

Traveling axis

A travelling axis can be installed in the robot, for examination of the operations of a system equipped with a traveling axis.

Calibration

The point sequence data of CAD coordinates created using CAD links is corrected into robot coordinate data, and the operations program and point sequence data are sent to the robot. In consideration of the frequent need for calibration onsite, the calibration tool is an application separate from SolidWorks®, designed to run efficiently on a laptop PC that does not have SolidWorks® software.

Please contact your local representative or sales office.

Multifunctional Electric Gripper Option

The multifunctional electric gripper option supports customer's various applications with various functions, great lineup, and highly accurate gripping

Highly advanced control impossible with air cylinders

Grip force/speed setting according to the target workpiece

Grip patterns can be set according to the grip target, such as soft workpieces and heavy workpieces, with the torque specification and grip speed setting.

Operation stroke setting according to the shape of the target workpiece

Even when target workpieces are different in size, the optimal stroke can be specified with the operation position specification.

Easily applied to inspection, in addition to workpiece handling

Applications to inspection are possible with feedbacks of the torque or position of the gripper, including whether a workpiece is gripped or not or whether a workpiece is acceptable or not with workpiece dimension measurement.

New applications will be available.

Components

	Name	Quantity	Remarks
1)	Electric gripper	1	Select the model by the grip force and stroke.
	Electric gripper control unit	1	Connected to the electric gripper.
2)	gripper cable	1	Connects the electric gripper and control unit.
	Robot cable	1	The cable type differs depending on the robot model.

Specifications of the electric gripper control unit

Item	Specifications	Remarks
External dimensions	60 (W) × 60 (D) × 40 (H)	
Weight	Approx. 200 g	
Input power source	24 V DC ±10%, 1 A (max.)	Powered by the robot controller (Customers need to prepare no power supplies.)
No. of teaching points	32 points	Position data for multiple-point position control

* Only one model of the electric gripper control unit is available for the electric grippers.

(Note 1) To install the electric gripper to a mechanical interface, fabricate an attachment separately.

(Note 2) The cable of the electric gripper is not designed to be resistant to bending. Take cautions to prevent any stress from applying to the cable while the robot is operating.

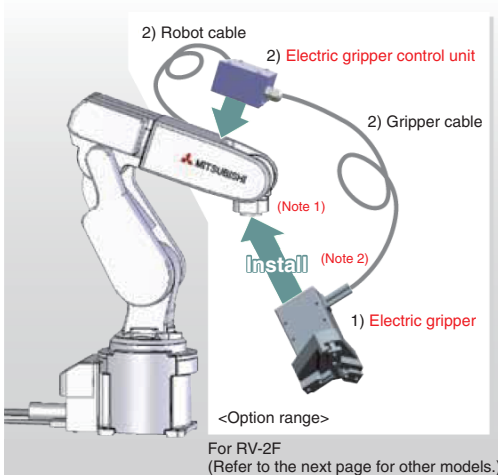

<Electric gripper>

Item	Specifications	Exterior image	
2-claw type (4 models)	Max. grip force	5.0 to 150N	
	Grip force adjustment range	100 to 30% of the max. grip force	
	Stroke	3.2 to 38mm	
	Max. speed	100mm/s(Screw type : 50mm/s)	
	Min. speed	20mm/s	
	Max. grip weight	0.05 to 1.5kg	
	Repetitive stop accuracy	±0.01 to 0.02mm	
Weight	90 to 890g		
2-claw type (1 models)	Max. grip force	2.0N	
	Grip force adjustment range	100 to 30% of the max. grip force	
	Stroke	13mm	
	Max. speed	100mm/s	
	Min. speed	20mm/s	
	Max. grip weight	0.02kg	
	Repetitive stop accuracy	±0.03mm	
Weight	190g		

Type	Model	Stroke(mm)	Grip force(N)	
2-claw type	Single-cam type	4F-MEHGR-01	3.2	1.5 to 5
		4F-MEHGR-02	7.6	1.8 to 6
		4F-MEHGR-03	14.3	6.6 to 22
	Screw type	4F-MEHGR-04	38	45 to 150
3-claw type	4F-MEHGR-05	13	0.6 to 2	

Please contact your local representative or sales office.

Configuration requirement of the multi-function electric gripper

RV-2F series

No.	Name: model	Quantity	Purchased at	Remarks
1	Electric gripper	1	Mitsubishi Electric	Electric gripper used by customers
2	Control unit for the electric gripper: 4F-MEHCU-01	1	Mitsubishi Electric	
3	Electric gripper installation flange	1	Fabricated by customers	Electric gripper used by customers
4	Robot	1	Mitsubishi Electric	Standard specifications
5	Banding band/fixing plate	As required	Fabricated by customers	For fixing a cable

RV-4F/7F/20F series, external wiring specifications

No.	Name: model	Quantity	Purchased at	Remarks
1	Electric gripper	1	Mitsubishi Electric	Electric gripper used by customers
2	Control unit for the electric gripper: 4F-MEHCU-02	1		
3	Adapter cable: 4F-MEHCBL-01	1	Fabricated by customers	For fixing the tip of the electric gripper
4	Electric gripper installation flange	1		
5	Electric gripper control unit installation stand	1		
Robot				
6	Robot, standard (external wiring) specifications	1	Mitsubishi Electric	Standard specifications External wiring sets (option) need to be connected to each of the forearm part and base part.
7	External wiring unit for the base	1		1F-HA01S-01: When the gripper input signal and Ethernet signal are used together 1F-HA02S-01: When the force sensor signal and Ethernet signal are used together
8	External wiring unit for the forearm	1		1F-HA01S-01: When the gripper input signal and Ethernet signal are used together 1F-HA02S-01: When the force sensor signal and Ethernet signal are used together
9	Wrist wiring internal-wiring specifications: RV-□F-SH02/SH-03	1		Wrist wiring custom specifications SH-02: When the gripper input signal and vision sensor signal are used together SH-03: When the force sensor signal and vision sensor signal are used together

RH-3/6/12/20F series

No.	Name: model	Quantity	Purchased at	Remarks	
1	Electric gripper	1	Mitsubishi Electric	Electric gripper used by customers	
2	Control unit for the electric gripper: 4F-MEHCU-02	1			
3	Relay cable	1			
	RH-3FH35/45/5515 & C specifications Z=120 RH-6FH(M)(C)35/45/5520	4F-MEHCBL-02 (Length: 1300 + 150 mm)			1
	RH-6FH(M)(C)35/45/5534	4F-MEHCBL-03 (Length: 1600 + 150mm)			1
	RH-12FH(M)(C)55/70/8535 RH-20FH(M)(C)8535	4F-MEHCBL-04 (Length: 1800 + 150mm)	1		
4	Banding band, nylon clamp, etc.	1	Fabricated by customers	For fixing a cable	
		1	Fabricated by customers	For fixing the shaft tip of the electric gripper	

RV-4F/7F/13F/20F series, piping internal wiring specifications

Specifications	Possible gripper configuration	Accessory		Remarks
		External wiring set for the forearm	External wiring set for the base	
-SH02	<ul style="list-style-type: none"> Electric gripper + gripper input signal Vision sensor 	-	1F-HA01S-01	An external wiring set for the base is enclosed with the internal wiring type robot.
-SH03	<ul style="list-style-type: none"> Electric gripper Vision sensor Force sensor 	-	1F-HA02S-01	

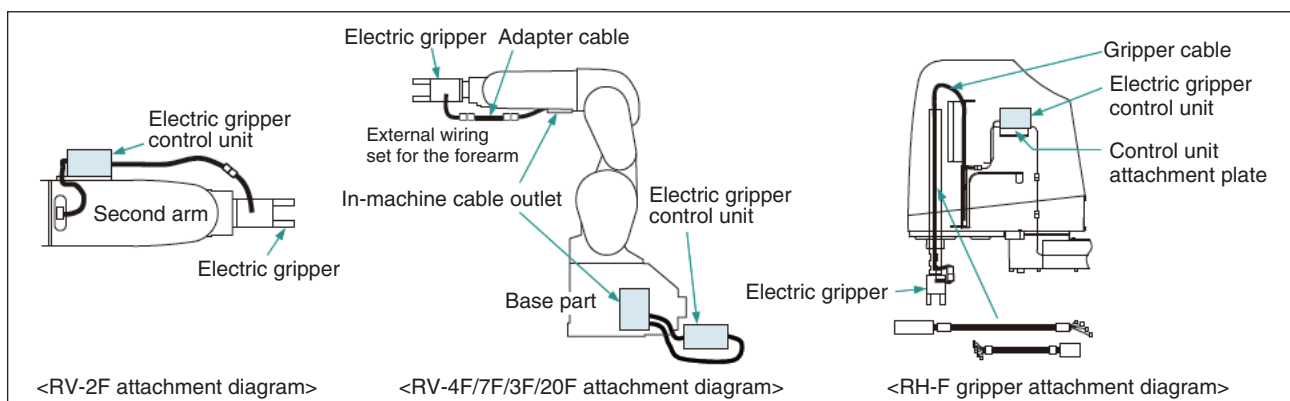

WIRING SOLUTION

ASLINK (Manufactured by AnyWire: Exclusively for Mitsubishi Electric robots)

The AnyWire ASLINK wiring system can be incorporated in MELFA robots, to resolve gripper wiring problems. By connecting the AnyWire dedicated cable unit to the standard wiring of a conventional robot, all 256 I/O points of the robot gripper can be used without drawing external wiring to the robot arm.

By introducing AnyWire ASLINK...

Before introduction

Issues:

- Limited number of wires in multi-core cable
- Increased size due to relay box
- Increased weight
- Frequent stoppages due to disconnection

After introduction

Improvements:

- Larger number of points with fewer wires
- Elimination of relay box
- Conversion with easy additions and detachments
- Easy assembly using connector branches
- Reduced risk of disconnection with the use of internal cables

MELFA × AnyWire ASLINK wiring/device calibration

No.	Device	Model	Quantity	Supplier	Remarks
①	Forearm external wiring set	1F-HB02S-01	1	Mitsubishi Electric	
②	Base external wiring set	1F-HA02S-01	1	Mitsubishi Electric	
③	AnyWire ASLINK unit	To be selected as required	n	AnyWire	
④	Forearm conversion adapter cable	BL2-RVAS	1	AnyWire	200mm fixed cable
⑤	Base conversion adapter cable	BL2-RVBS	1	AnyWire	200mm fixed cable
⑥	AnyWire ASLINK master unit	QJ51AW12AL	1	Mitsubishi Electric	For Mitsubishi Electric PLCs

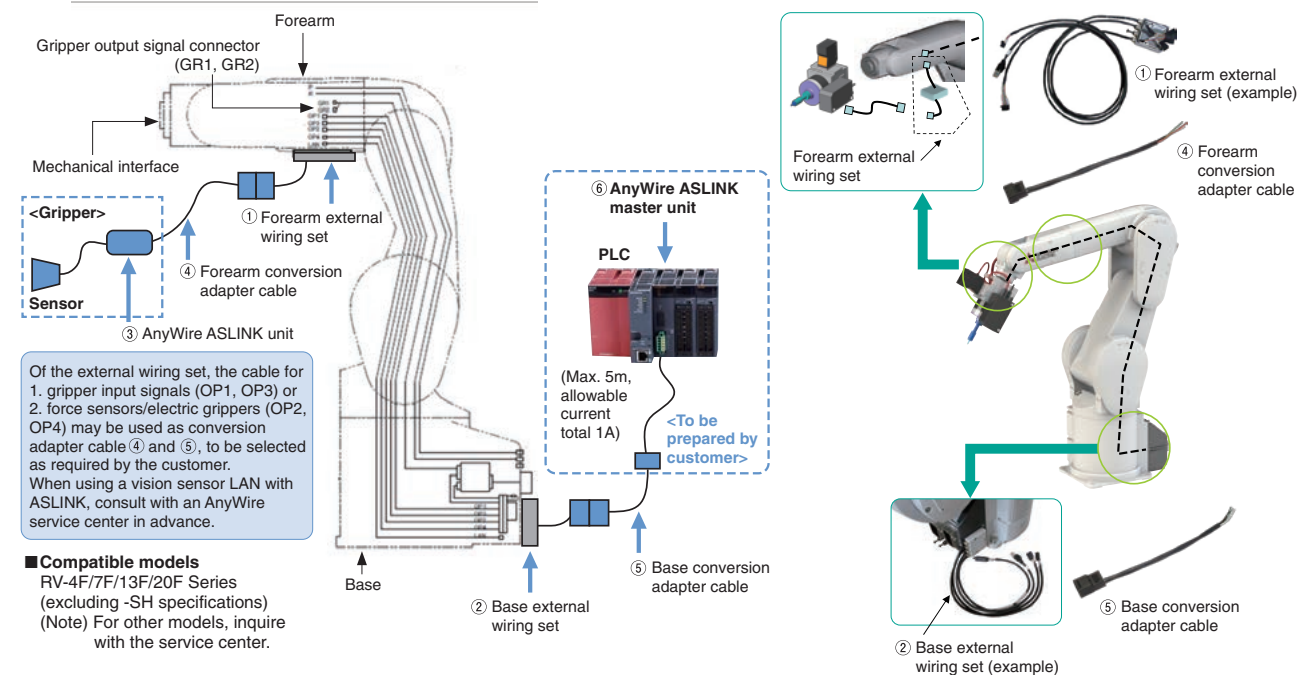

Calculating the Inertia

A tolerable inertia is set in the mechanical interface for robot arm. If a load exceeding this inertia is mounted, the robot may vibrate or an overload alarm may occur when the robot moves. When selecting the robot, it must be considered whether the hand or load to be mounted on the arm is suitable. The method of calculating the load inertia is explained below.

Example 1 Horizontally articulated robot

Calculate the total inertia around the J4 axis.

$$I = I_{z1} + I_{z2} + W_1 L_1^2 + W_2 L_2^2$$

I : Total inertia around the J4 axis
I_z : Load inertia
W : Each weight (kg)

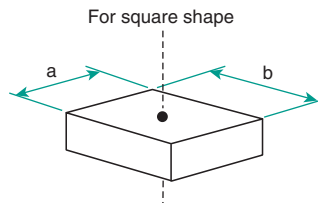
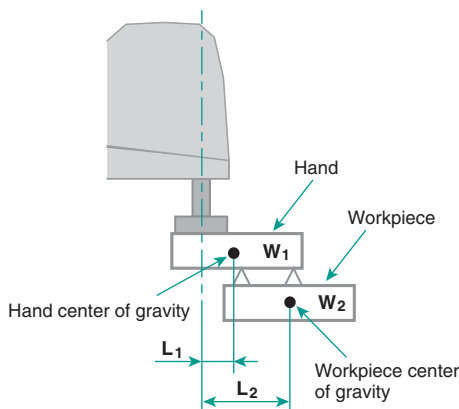

For square shape

$$\text{Load inertia: } I_z = W \cdot \frac{a^2 + b^2}{12}$$

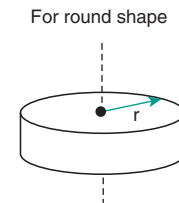

For round shape

$$\text{Load inertia: } I_z = W \cdot \frac{r^2}{2}$$

[Example of calculation]

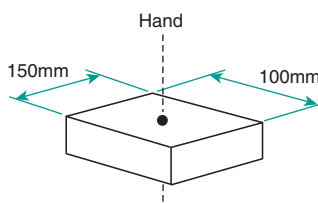
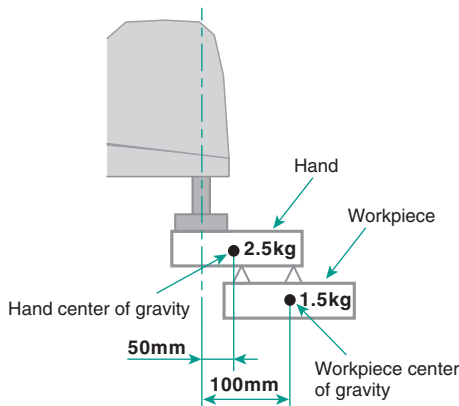

Hand

$$\text{Load inertia: } I_{z1} = 2.5 \times \frac{0.15^2 + 0.1^2}{12} = 0.0068 \text{ kg} \cdot \text{m}^2$$

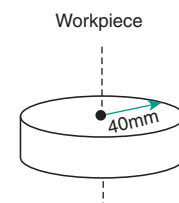

Workpiece

$$\text{Load inertia: } I_{z2} = 1.5 \times \frac{0.04^2}{2} = 0.0012 \text{ kg} \cdot \text{m}^2$$

The total inertia around the J4 axis:

$$I = 0.0068 + 0.0012 + 2.5 \times 0.05^2 + 1.5 \times 0.1^2 = 0.030 \text{ kg} \cdot \text{m}^2$$

The RH-6FRH tolerable inertia (rating) is 0.01 kg·m² so 0.030 kg·m² exceeds the tolerable inertia.

However, if the hand center of gravity is aligned with the J4 rotary axis, and the workpiece is grasped directly below the J4 axis, both L₁ and L₂ become zero (0), so the total inertia around J4 axis can be determined by the following formula:

$$I = 0.0068 + 0.0012 = 0.008 \text{ kg} \cdot \text{m}^2 < 0.01 \text{ kg} \cdot \text{m}^2$$

This falls within the tolerable inertia.

Even if the total inertia is exceeded, consider changing the grasping method or changing the position.

TECHINICAL INFORMATION

Example 2 For vertically articulated robot

With the vertical articulated robot, the load moment for the wrist axis (J4 axis to J6 axis) and the load inertia for the wrist axis (J4 axis to J6 axis) must be reviewed. Consider the hand to be used and the posture of the workpiece, and calculate the load moment and load inertia applied on each of J4 axis to J6 axis. An example of the review is shown below.

Example for calculating load moment (For J5 axis with flange facing downward)

Assume the following conditions as shown on the right:

Hand weight : W_1 (kg)

Hand center of gravity position : L_1 (m)

Workpiece weight : W_2 (kg)

Workpiece center of gravity position : L_2 (m)

In this case, the load moment applied on the J5 axis is determined as follows.

Where, g : gravitational acceleration (m/sec^2).

$$J5 \text{ axis load moment (Nm): } M = W_1 \times L_1 \times g + W_2 \times L_2 \times g$$

Confirm that this value M falls within the tolerable moment of the model to be selected.

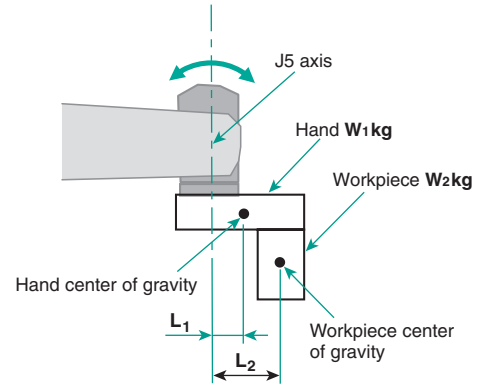

Example of calculating load inertia (For J6 axis)

Assume the following conditions as shown on the right:

Hand weight : W_1 (kg)

Distance from the J6 axis center to the hand center of gravity position : L_1 (m)

Workpiece weight : W_2 (kg)

Workpiece center of gravity position : L_2 (m)

In this case, the load inertia applied on the J6 axis rotation is determined as follows.

as follows.

The hand and workpiece shapes shall be square respectively, with dimensions of $a_1 \times b_1$ and $a_2 \times b_2$ respectively.

(a: Vertical length, b: Horizontal length)

Load inertia around the hand J6 axis ($kg \cdot m^2$):

$$I_1 = I_{z1} + W_1 \times L_1^2 = W_1 \times (a_1^2 + b_1^2)/12 + W_1 \times L_1^2$$

Load inertia around the workpiece J6 axis ($kg \cdot m^2$):

$$I_2 = I_{z2} + W_2 \times L_2^2 = W_2 \times (a_2^2 + b_2^2)/12 + W_2 \times L_2^2$$

Load inertia around the J6 axis ($kg \cdot m^2$) based on the hand + workpiece:

$$I = I_1 + I_2$$

Confirm that this value falls within the tolerable inertia of the model to be selected.

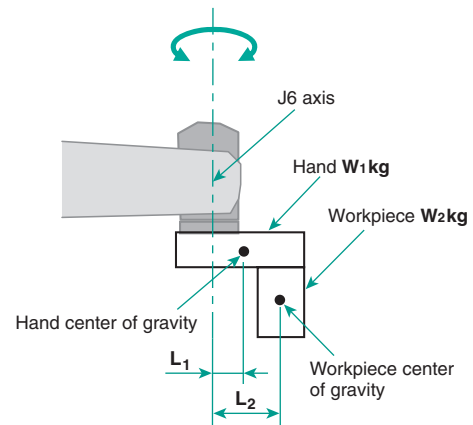

Note) If the posture change other than in the downward direction is large, the load moment around J4 axis must also be confirmed.

YOUR SOLUTION PARTNER

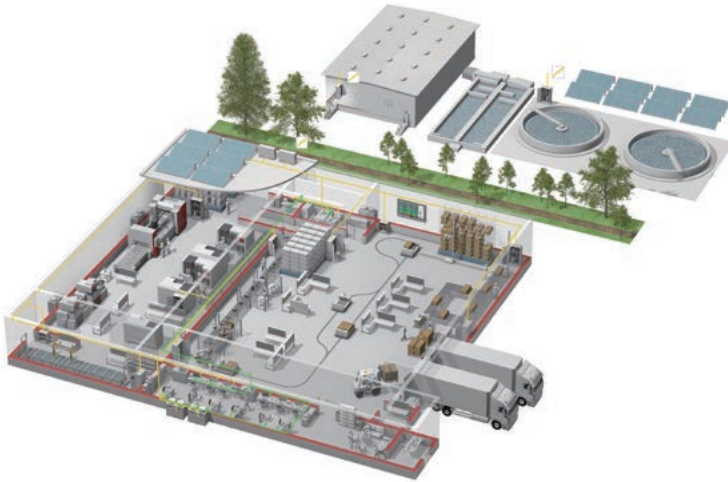

Mitsubishi Electric offers a wide range of automation equipment from PLCs and HMIs to CNC and EDM machines.

A NAME TO TRUST

Since its beginnings in 1870, some 45 companies use the Mitsubishi name, covering a spectrum of finance, commerce and industry.

The Mitsubishi brand name is recognized around the world as a symbol of premium quality.

Mitsubishi Electric Corporation is active in space development, transportation, semi-conductors, energy systems, communications and information processing, audio visual equipment and home electronics, building and energy management and automation systems, and has 237 factories and laboratories worldwide in over 121 countries.

This is why you can rely on Mitsubishi Electric automation solution - because we know first hand about the need for reliable, efficient, easy-to-use automation and control in our own factories.

As one of the world's leading companies with a global turnover of over 4 trillion Yen (over \$40 billion), employing over 100,000 people, Mitsubishi Electric has the resource and the commitment to deliver the ultimate in service and support as well as the best products.



Low voltage: MCCB, MCB, ACB



Medium voltage: VCB, VCC



Power monitoring, energy management



Compact and Modular Controllers



Inverters, Servos and Motors



Visualisation: HMIs



Numerical Control (NC)



Robots: SCARA, Articulated arm



Processing machines: EDM, Lasers, IDS



Transformers, Air conditioning, Photovoltaic systems

* Not all products are available in all countries.

Global Partner. Local Friend.

American Offices

USA Mitsubishi Electric Automation, Inc. 500 Corporate Woods Parkway, Vernon Hills, IL 60061, USA. Tel: +1-847-478-2100	Brazil Mitsubishi Electric do Brasil Comercio e Servicos Ltda. Rua Jussara, 1750- Bloco B- Sala 01, Jardim Santa Cecilia, CEP 06465-070, Barueri - SP, Brasil Tel: +55-11-4689-3000
--	---

Asia-Pacific Offices

China Mitsubishi Electric Automation (China) Ltd. No.1386 Hongqiao Road, Mitsubishi Electric Automation Center 3F Shanghai, China Tel: +86-21-2322-3030	Taiwan Mitsubishi Electric Taiwan Co.,Ltd. 10F.No.88,Sec.6,Chung-Shan N.Rd.,Taipei,Taiwan Tel: +886-02-2833-5430	Korea Mitsubishi Electric Automation Korea Co., Ltd. 7F-9F, Gangseo Hangang Xi-tower A, 401, Yangcheon-ro, Gangseo-Gu,Seoul 157-801, Korea Tel: +82-2-3660-9550
Singapore Mitsubishi Electric Asia Pte. Ltd. 307 Alexandra Road #05-01/02, Mitsubishi Electric Building, Singapore Tel: +65-6470-2480	Thailand MITSUBISHI ELECTRIC FACTORY AUTOMATION (THAILAND) CO., LTD. 896/19 and 20,12 th Floor, SV. City Building, Office Tower 1, Rama 3 Road, Kwaeng Bangpongpan, Yannawa, Bangkok, 10120, Thailand Tel: +66-2682-6522	India Mitsubishi Electric India Pvt. Ltd. Emerald House, EL -3, J Block, M.I.D.C., Bhosari, Pune - 411026, Maharashtra State, India Tel: +91-2710-2000

European Offices

Germany Mitsubishi Electric Europe B.V. German Branch Mitsubishi-Electric-Platz 1, 40882 Ratingen, Germany Tel: +49-2102-486-0	UK Mitsubishi Electric Europe B.V. UK Branch Travellers Lane, Hatfield, Hertfordshire, AL10 8XB, U.K. Tel: +44-1707-27-6100	Italy Mitsubishi Electric Europe B.V. Italian Branch VIALE COLLEONI 7-20041 Agrate Brianza (Milano), Italy Tel: +39-039-60531
Spain Mitsubishi Electric Europe B.V. Spanish Branch Carretera de Rubi 76-80-AC.4720, E-08190 Sant Cugat del Valles (Barcelona), Spain Tel: +34-935-65-3131	France Mitsubishi Electric Europe B.V. French Branch 25, Boulevard des Bouvets, F-92741 Nanterre Cedex, France Tel: +33-1-5568-5568	Czech Republic Mitsubishi Electric Europe B.V. Czech Branch Avenir Business Park, Radicka 714/113a,158 00 praha 5, Czech Republic Tel: +420-251-551-470
Poland Mitsubishi Electric Europe B.V. Polish Branch ul. Krakowska 50 32-083 Balice, Poland Tel: +48-12-630-47-00	Ireland Mitsubishi Electric Europe B.V. Irish Branch Westgate Business Park, Ballymount, IRL-Dublin 24 Tel: +353-14198800	Russia Mitsubishi Electric Europe B.V. Russian Branch Moscow Office 52, bld. 3, Kosmodamianskaya nab., RU-115054, Moscow, Russia Tel: +7-495-721-2070

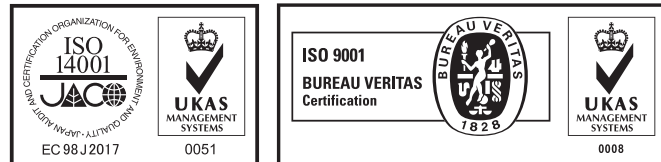

MITSUBISHI ELECTRIC CORPORATION

HEAD OFFICE: TOKYO BLDG., 2-7-3 MARUNOUCHI,
 CHIYODA-KU, TOKYO 100-8310, JAPAN